

VENTURKA 

*H-FWA
Cabinet Type
Axial Fan*

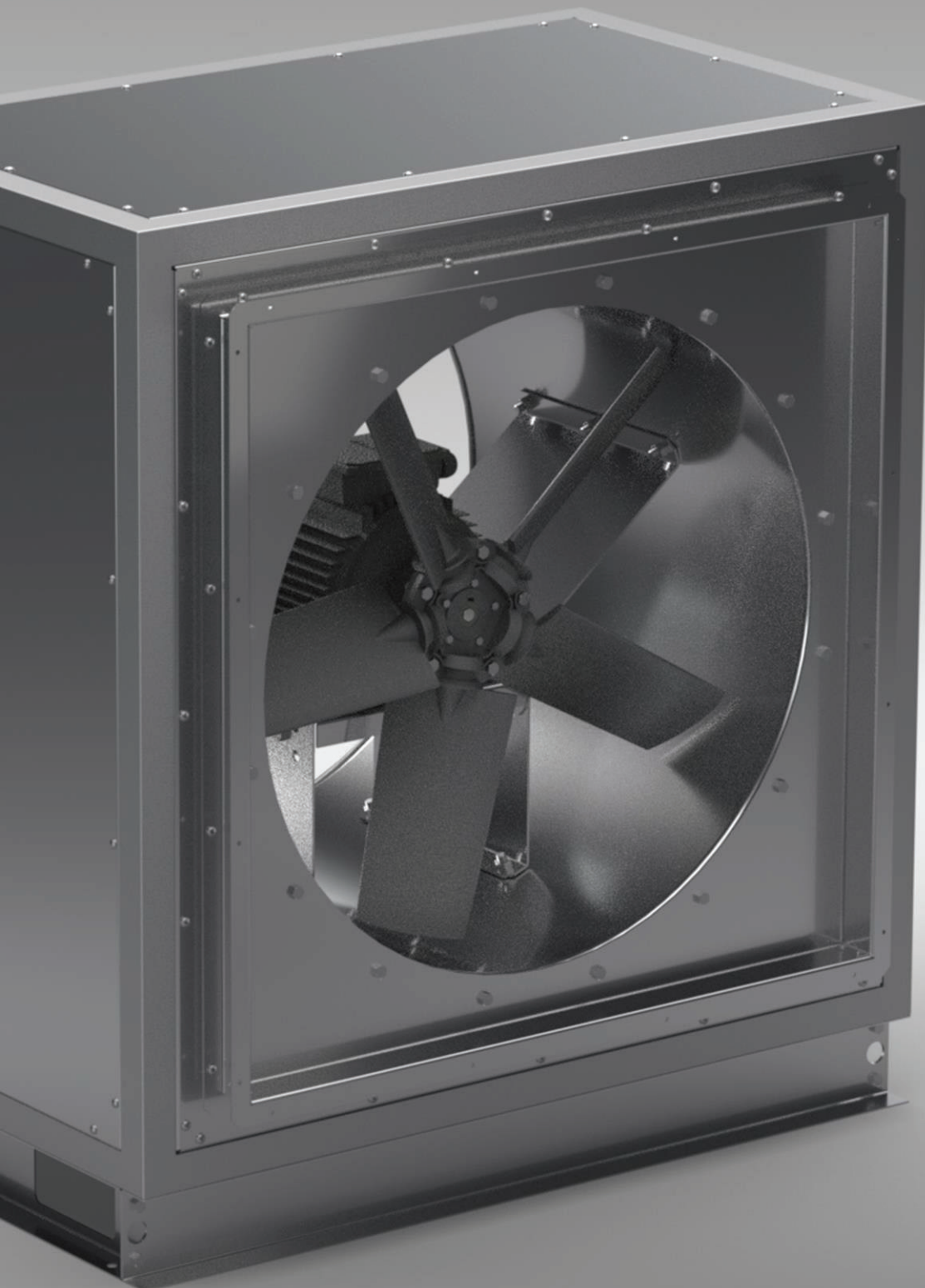

venturka.com

Technical Specifications

CABINET TYPE AXIAL FAN

H-FWA series axial fresh air fans are the ideal fans to meet the fresh air requirement in ventilation systems where high air flow is required. Thanks to their compact construction, they can be installed directly on roof/floor. H-FWA axial fans have high performance, trouble-free operation.

It is manufactured between Ø400mm and Ø1250mm diameters. The body is made of high quality, corrosion-resistant galvanized steel. The propellers are made of special aluminum alloy with adjustable blade angles. According to the project, uni-directional or reversible options are available. It is manufactured as standard (380 V - 50 Hz) or other voltages and frequencies (400/415/440 V - 50 Hz) on request. Motors can be single-speed or double speed and have Class H, S1, IP55 insulation. The sound level can be controlled by adding a silencer at the sensitive points.

Optionally, it can be manufactured with Ex-Proof feature.

Usage Areas

It can be used in all kinds of industrial, office, shopping mall, hospital, factory, parking lot and residential ventilation and pressurization systems.

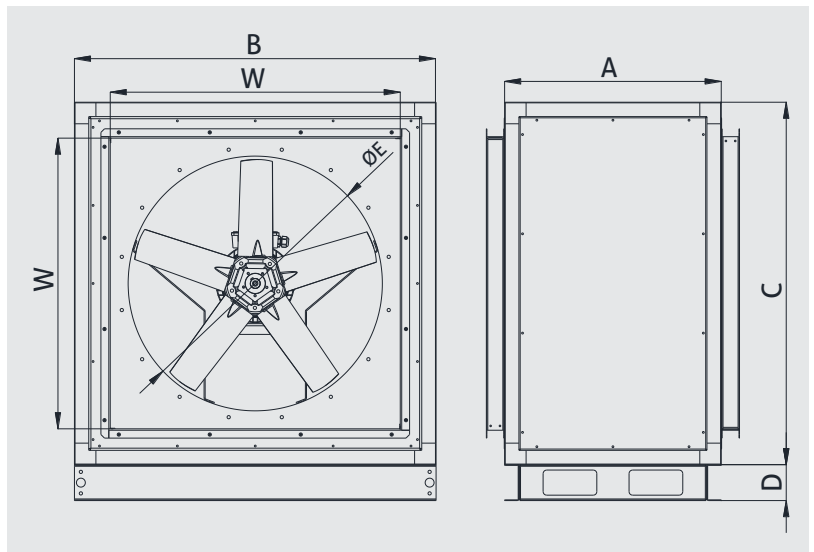

MODEL	A	B	C	D	E	W x H	VOLTAGE	FREQUENCY
	mm	mm	mm	mm	mm	mm	V	Hz
H-FWA 400	505	700	700	100	400	500x500	380	50
H-FWA 450	505	750	750	100	450	550x550	380	50
H-FWA 500	605	800	800	100	500	600x600	380	50
H-FWA 560	605	860	860	100	560	600x600	380	50
H-FWA 630	605	930	930	100	630	730x730	380	50
H-FWA 710	605	1010	1010	100	710	810x810	380	50
H-FWA 800	605	1100	1100	100	800	900x900	380	50
H-FWA 900	755	1200	1200	100	900	1000x1000	380	50
H-FWA 1000	805	1300	1300	100	1000	1100x1100	380	50
H-FWA 1120	1005	1420	1420	100	1120	1220x1220	380	50
H-FWA 1250	1005	1550	1550	100	1250	1350x1350	380	50

Performans Eğrileri

H-FWA 400

Nos. of Blades 3
Hub Size 6
Pitch Angle 45°
Nos. of Poles 2
Material Aluminum

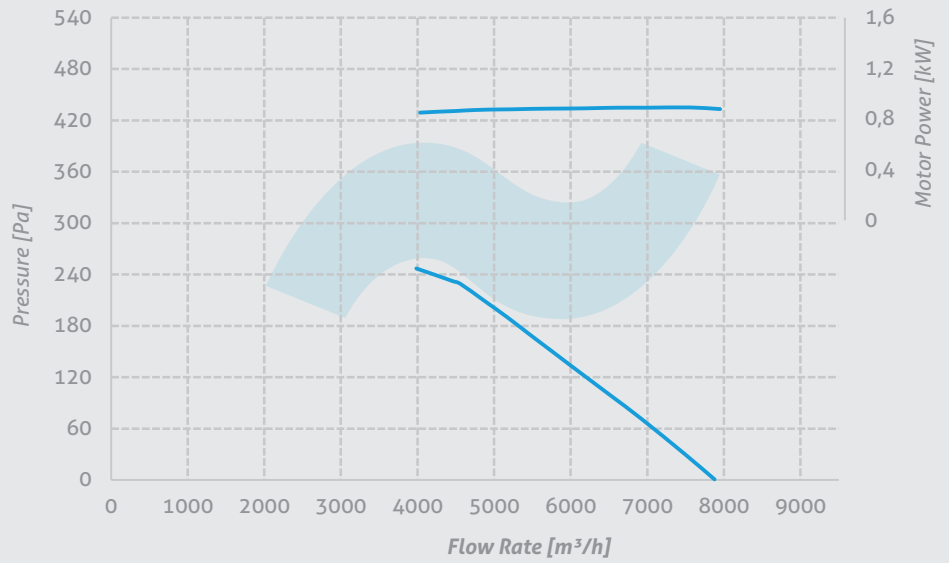

H-FWA 400

Nos. of Blades 3
Hub Size 6
Pitch Angle 45°
Nos. of Poles 4
Material Aluminum

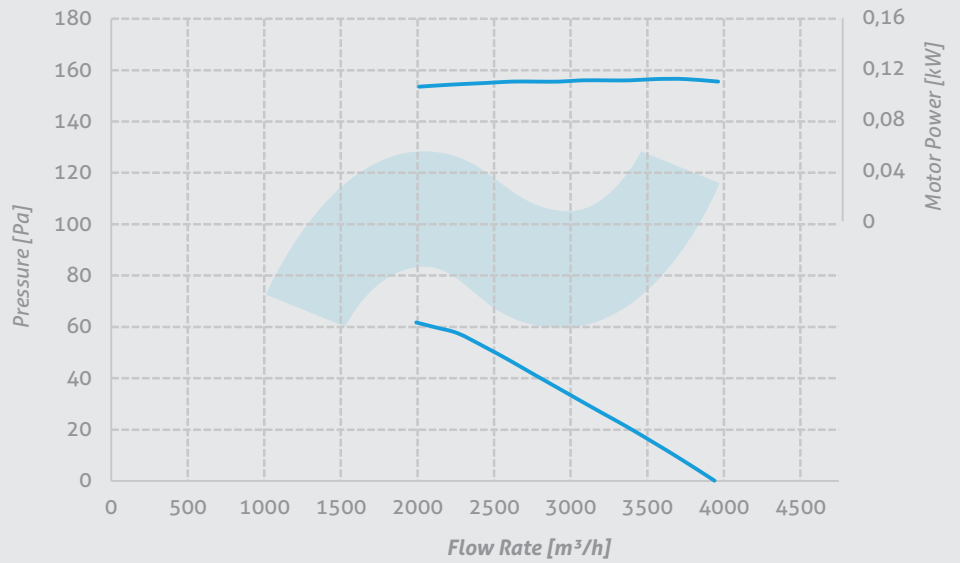

H-FWA 400

Nos. of Blades 3
Hub Size 6
Pitch Angle 45°
Nos. of Poles 6
Material Aluminum

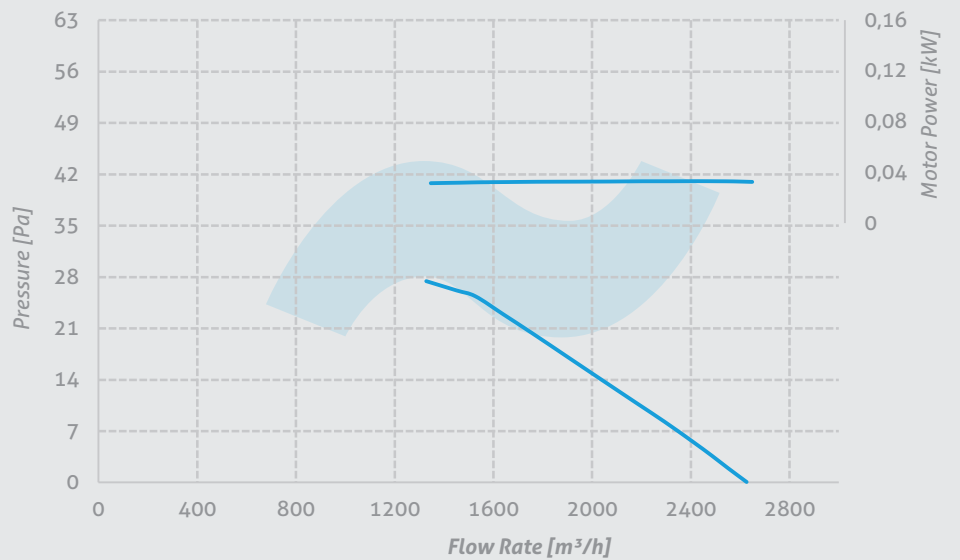

Performans Eğrileri

H-FWA 400

Nos. of Blades 6
Hub Size 6
Pitch Angle 45°
Nos. of Poles 2
Material Aluminum

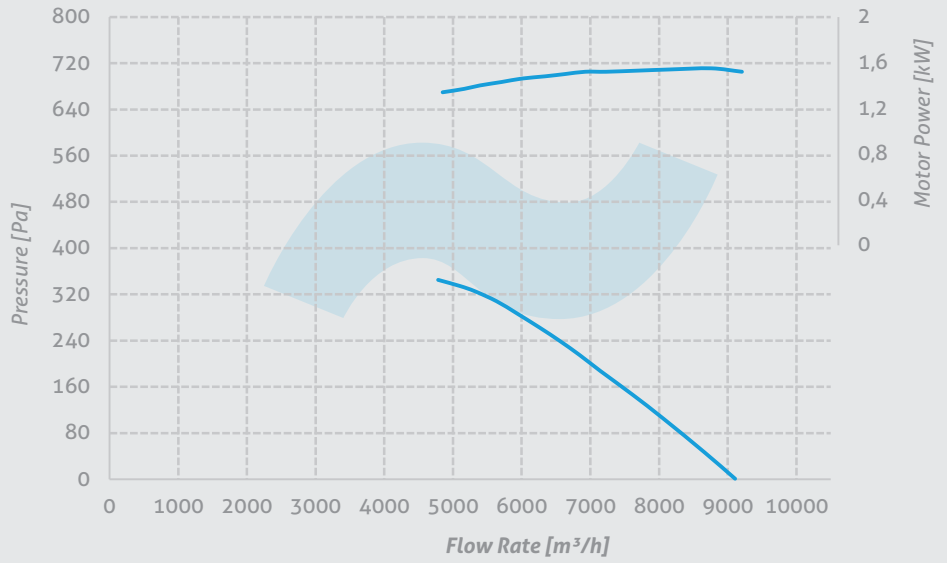

H-FWA 400

Nos. of Blades 6
Hub Size 6
Pitch Angle 45°
Nos. of Poles 4
Material Aluminum

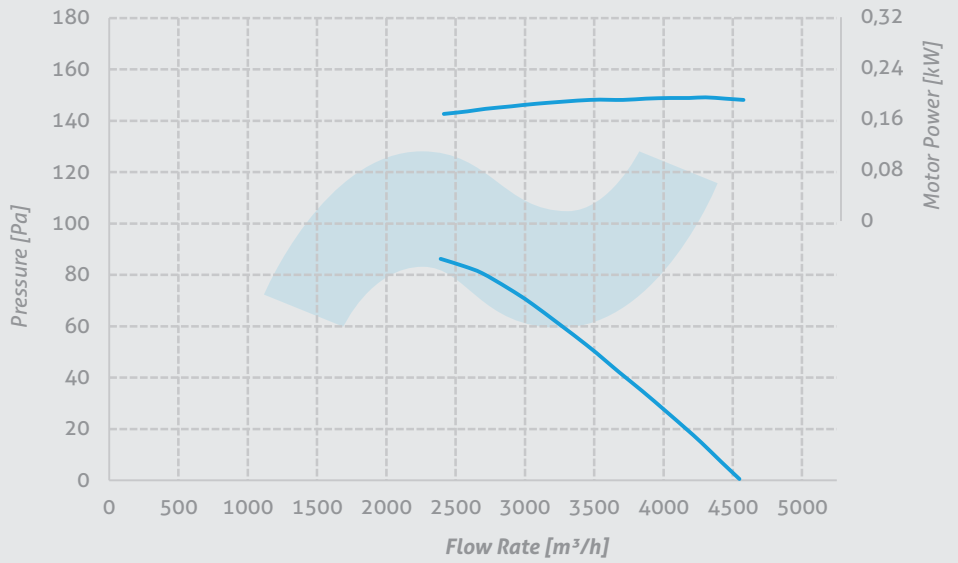

H-FWA 400

Nos. of Blades 6
Hub Size 6
Pitch Angle 45°
Nos. of Poles 6
Material Aluminum

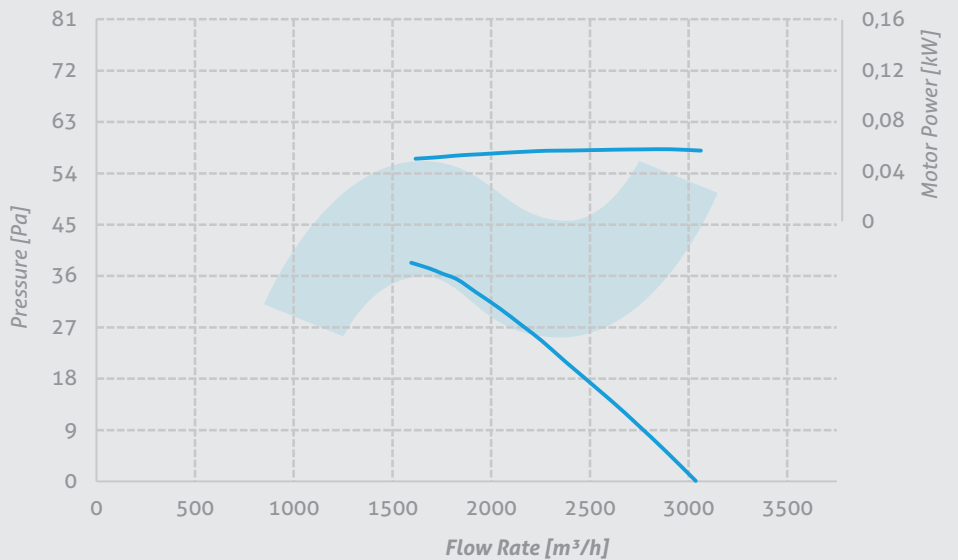

Performans Eğrileri

H-FWA 400

Nos. of Blades 5
 Hub Size 5
 Nos. of Poles 2
 Material Aluminum
 Pitch Angle

- 25° 30° 32,5°
- 35° 37,5° 40°
- 45° 50°

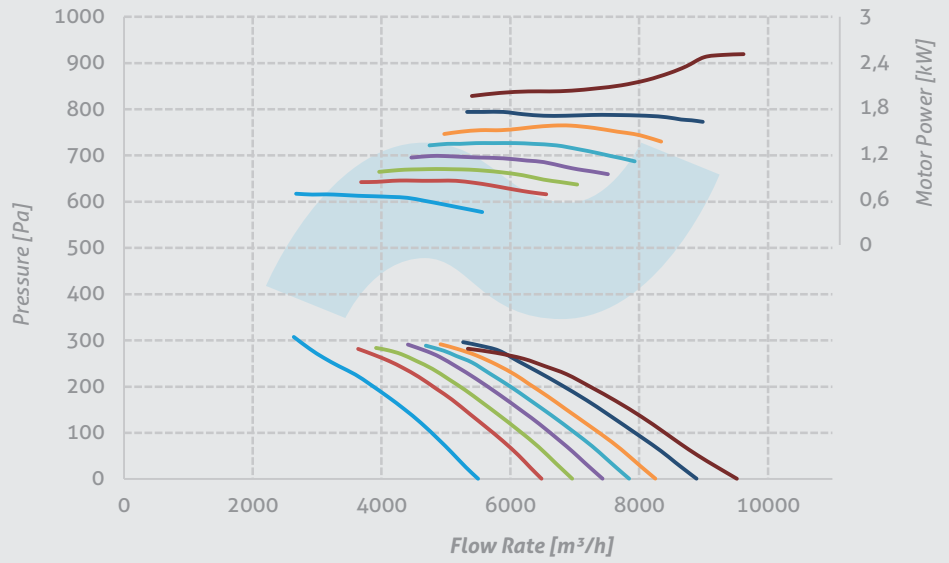

H-FWA 400

Nos. of Blades 5
 Hub Size 5
 Nos. of Poles 4
 Material Aluminum
 Pitch Angle

- 25° 30° 32,5°
- 35° 37,5° 40°
- 45° 50°

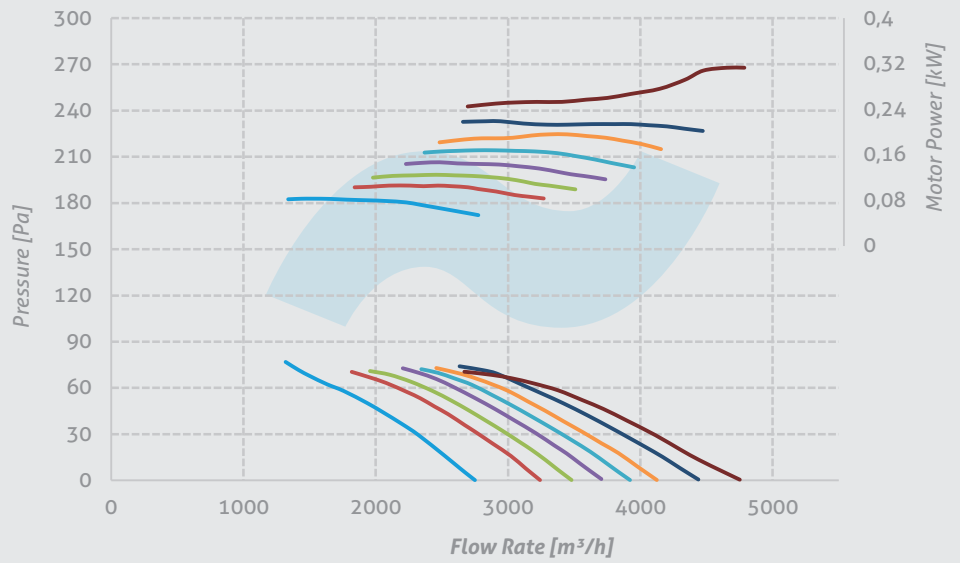

H-FWA 400

Nos. of Blades 5
 Hub Size 5
 Nos. of Poles 6
 Material Aluminum
 Pitch Angle

- 25° 30° 32,5°
- 35° 37,5° 40°
- 45° 50°

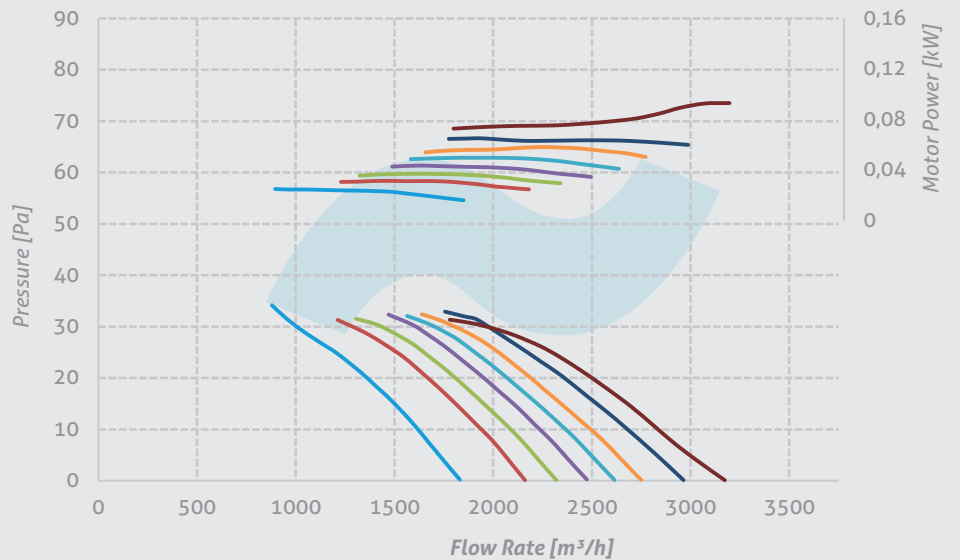

Performans Eğrileri

H-FWA 450

Nos. of Blades 3
Hub Size 6
Pitch Angle 45°
Nos. of Poles 2
Material Aluminum

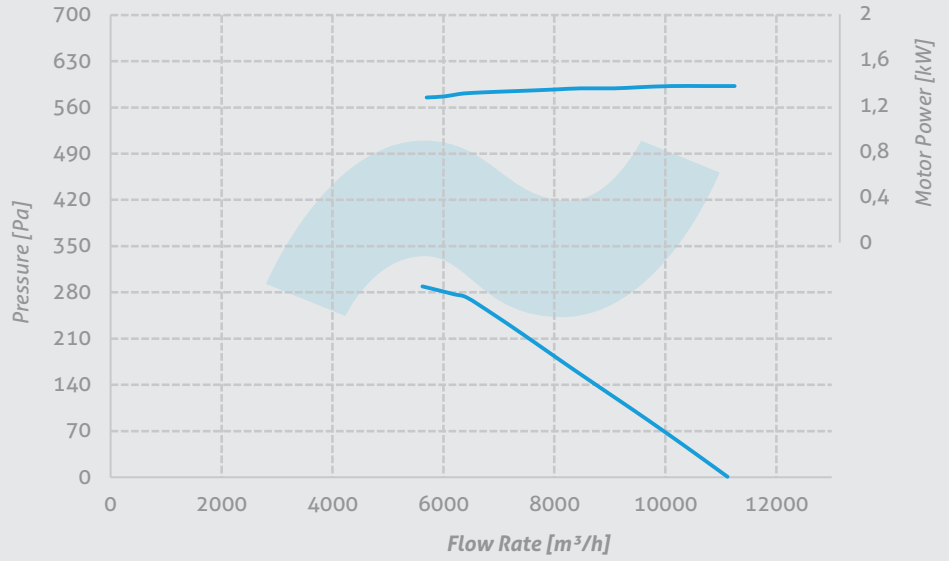

H-FWA 450

Nos. of Blades 3
Hub Size 6
Pitch Angle 45°
Nos. of Poles 4
Material Aluminum

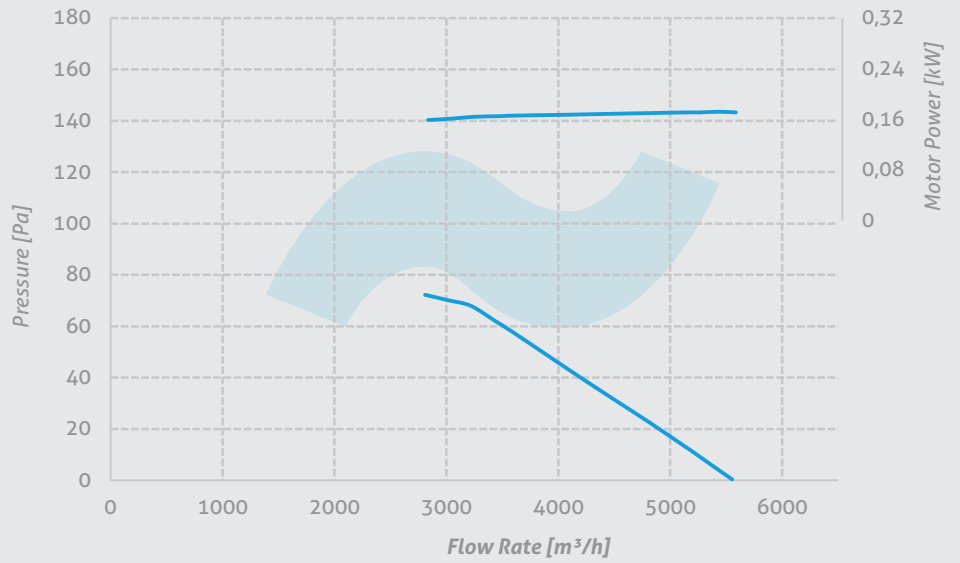

H-FWA 450

Nos. of Blades 3
Hub Size 6
Pitch Angle 45°
Nos. of Poles 6
Material Aluminum

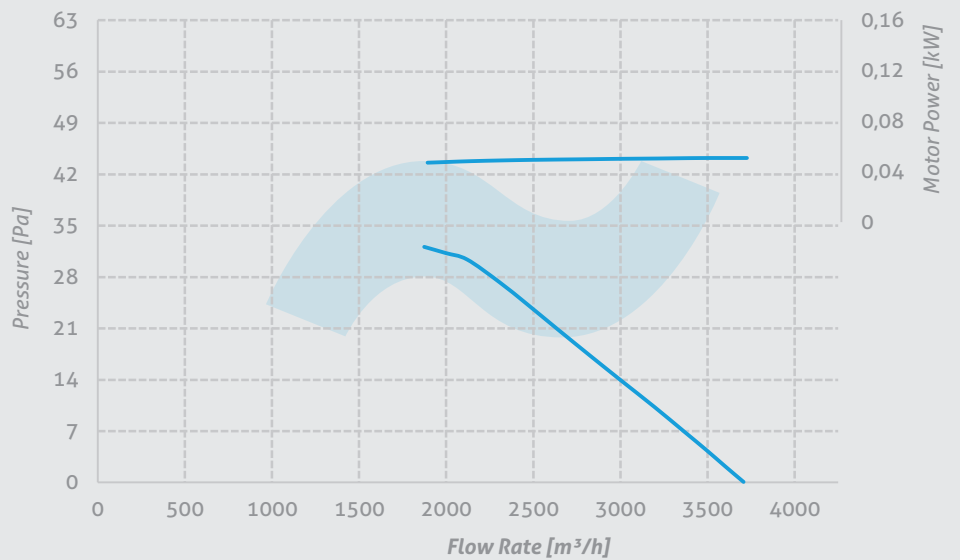

Performans Eğrileri

H-FWA 450

Nos. of Blades 6
Hub Size 6
Pitch Angle 45°
Nos. of Poles 2
Material Aluminum

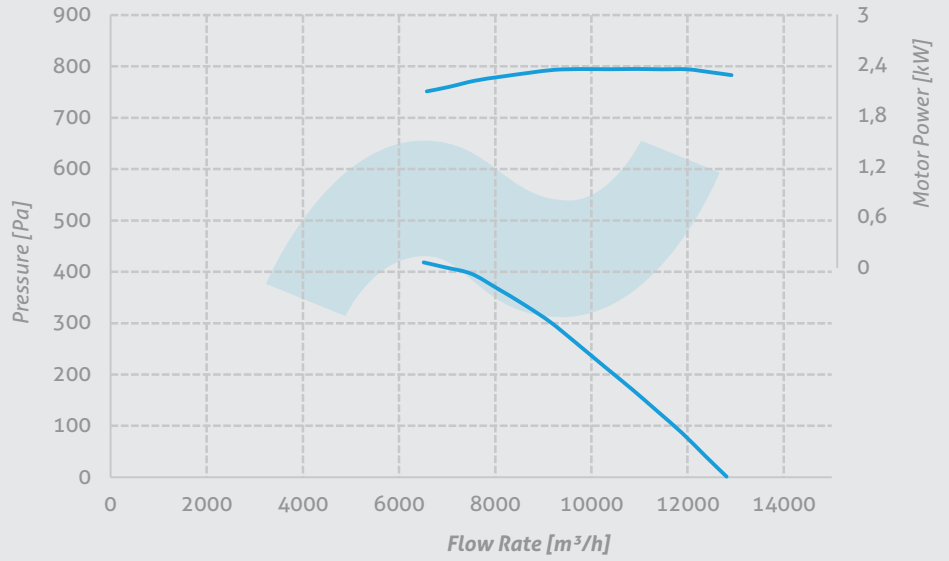

H-FWA 450

Nos. of Blades 6
Hub Size 6
Pitch Angle 45°
Nos. of Poles 4
Material Aluminum

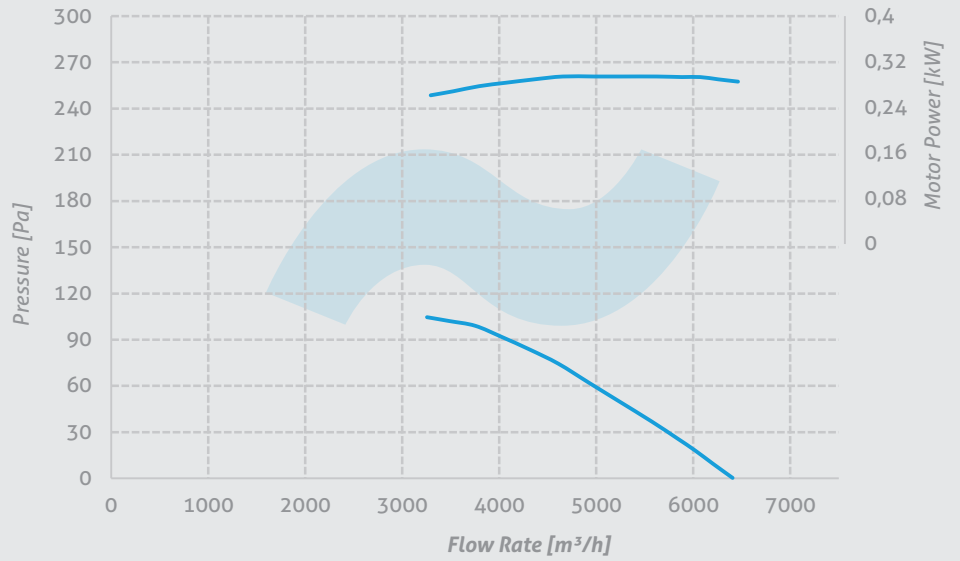

H-FWA 450

Nos. of Blades 6
Hub Size 6
Pitch Angle 45°
Nos. of Poles 6
Material Aluminum

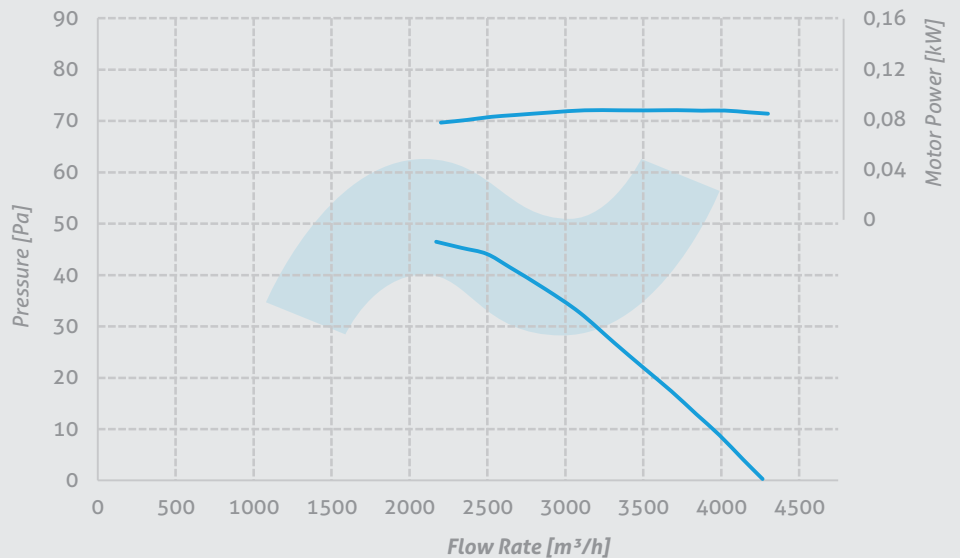

Performans Eğrileri

H-FWA 450

Nos. of Blades 5
 Hub Size 5
 Nos. of Poles 2
 Material Aluminum
 Pitch Angle

- 25° — 30° — 32,5°
- 35° — 37,5° — 40°
- 45° — 50°

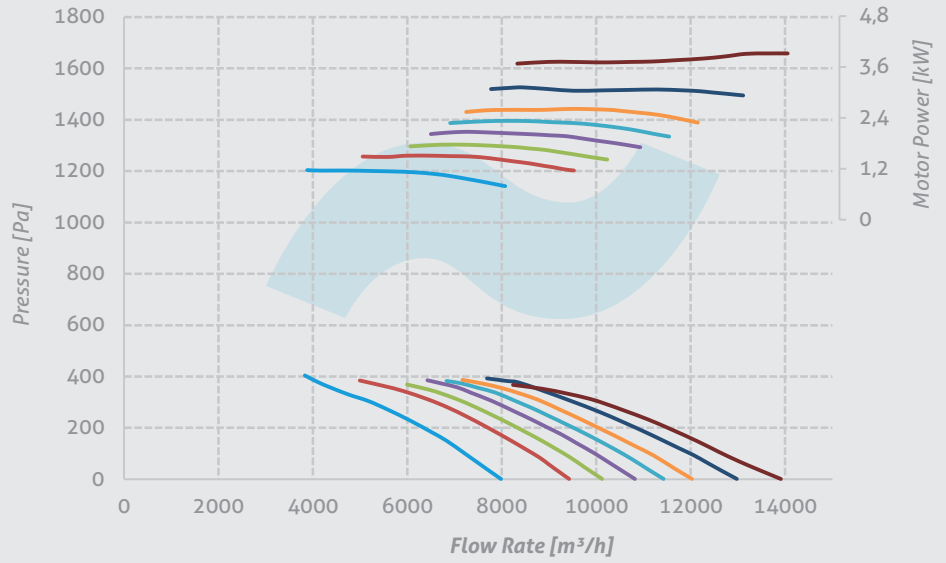

H-FWA 450

Nos. of Blades 5
 Hub Size 5
 Nos. of Poles 4
 Material Aluminum
 Pitch Angle

- 25° — 30° — 32,5°
- 35° — 37,5° — 40°
- 45° — 50°

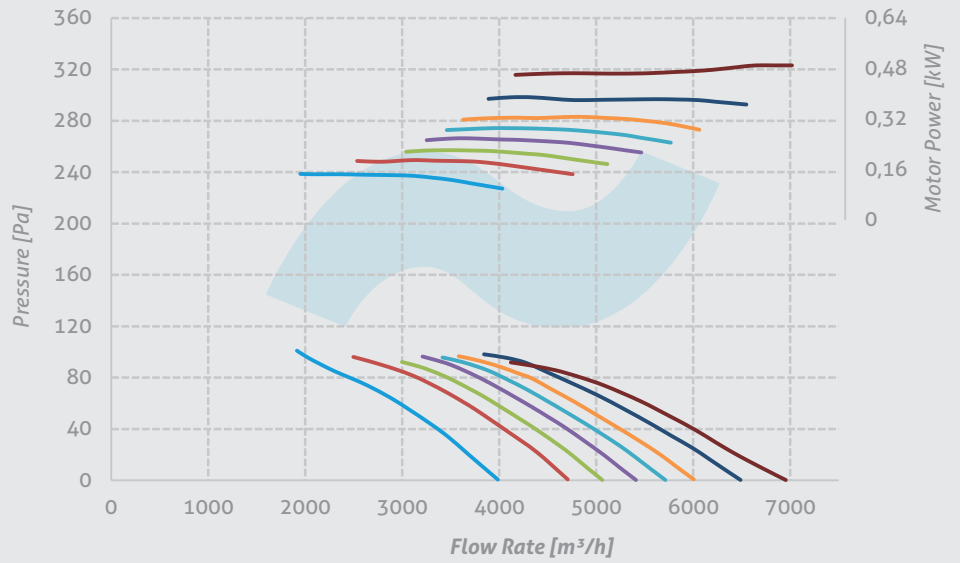

H-FWA 450

Nos. of Blades 5
 Hub Size 5
 Nos. of Poles 6
 Material Aluminum
 Pitch Angle

- 25° — 30° — 32,5°
- 35° — 37,5° — 40°
- 45° — 50°

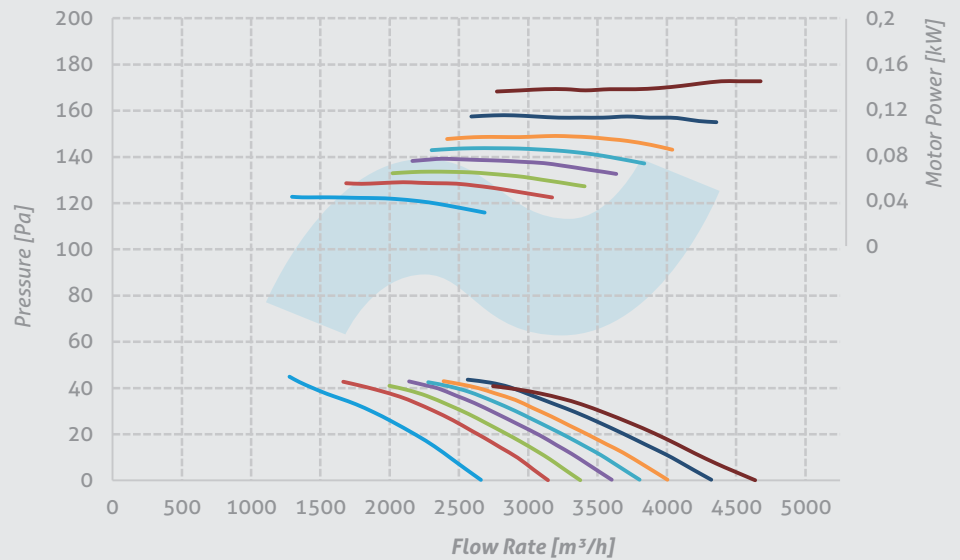

Performans Eğrileri

H-FWA 500

Nos. of Blades 3
Hub Size 6
Pitch Angle 45°
Nos. of Poles 2
Material Aluminum

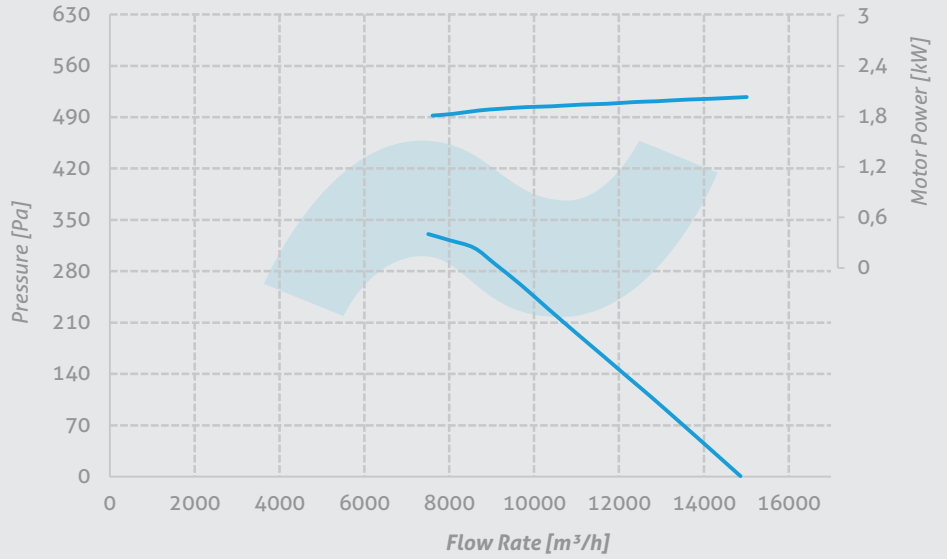

H-FWA 500

Nos. of Blades 3
Hub Size 6
Pitch Angle 45°
Nos. of Poles 4
Material Aluminum

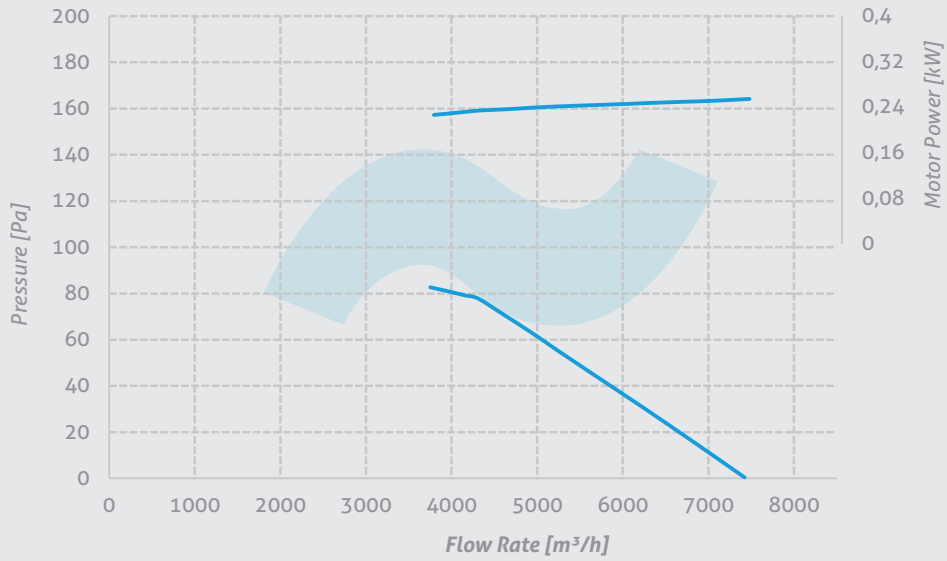

H-FWA 500

Nos. of Blades 3
Hub Size 6
Pitch Angle 45°
Nos. of Poles 6
Material Aluminum

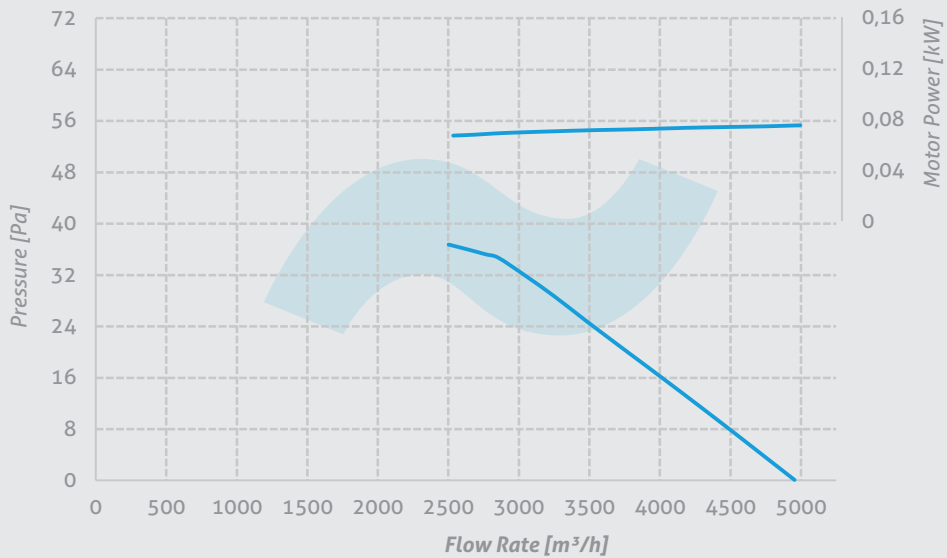

Performans Eğrileri

H-FWA 500

Nos. of Blades 6
Hub Size 6
Pitch Angle 45°
Nos. of Poles 2
Material Aluminum

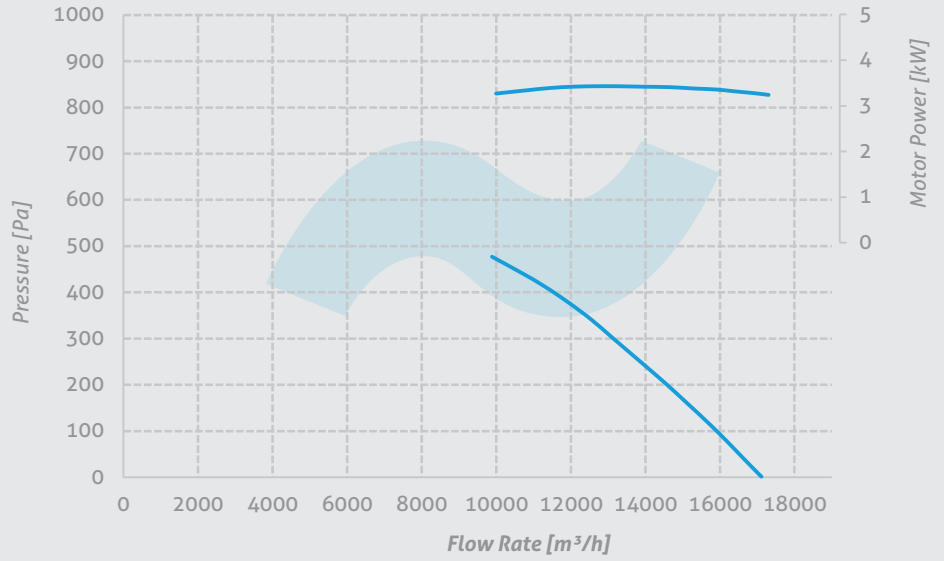

H-FWA 500

Nos. of Blades 6
Hub Size 6
Pitch Angle 45°
Nos. of Poles 4
Material Aluminum

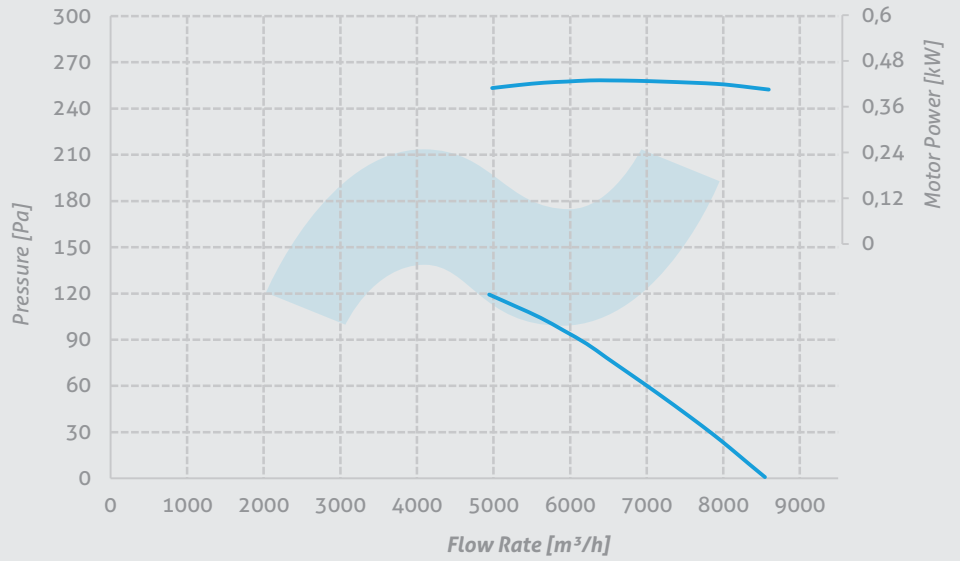

H-FWA 500

Nos. of Blades 6
Hub Size 6
Pitch Angle 45°
Nos. of Poles 6
Material Aluminum

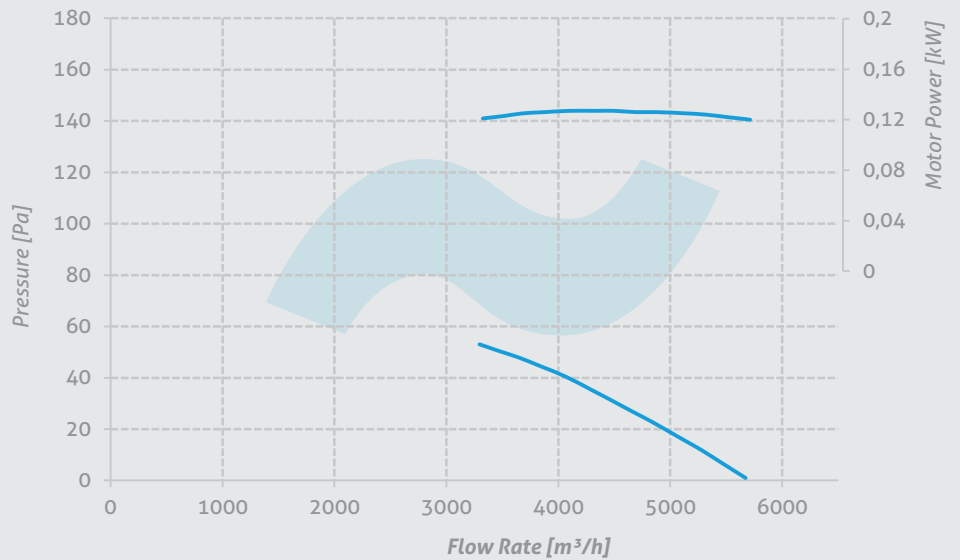

Performans Eğrileri

H-FWA 500

Nos. of Blades 5
 Hub Size 5
 Nos. of Poles 2
 Material Aluminum
 Pitch Angle

- 25° 30° 32,5°
- 35° 37,5° 40°
- 45° 50°

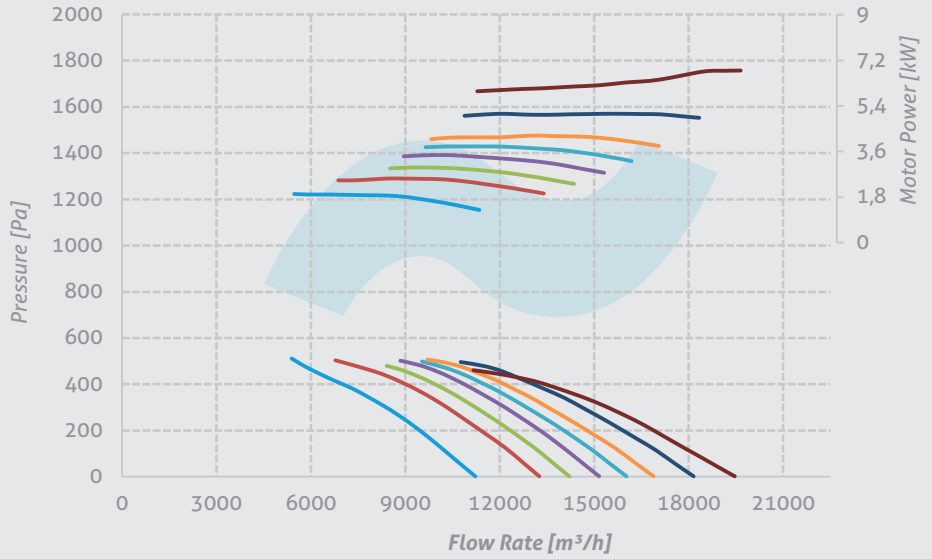

H-FWA 500

Nos. of Blades 5
 Hub Size 5
 Nos. of Poles 4
 Material Aluminum
 Pitch Angle

- 25° 30° 32,5°
- 35° 37,5° 40°
- 45° 50°

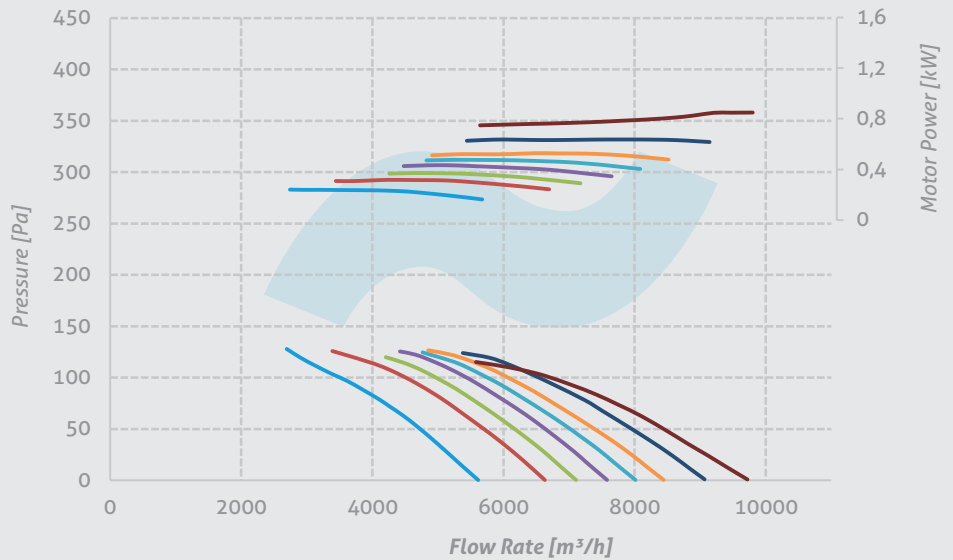

H-FWA 500

Nos. of Blades 5
 Hub Size 5
 Nos. of Poles 6
 Material Aluminum
 Pitch Angle

- 25° 30° 32,5°
- 35° 37,5° 40°
- 45° 50°

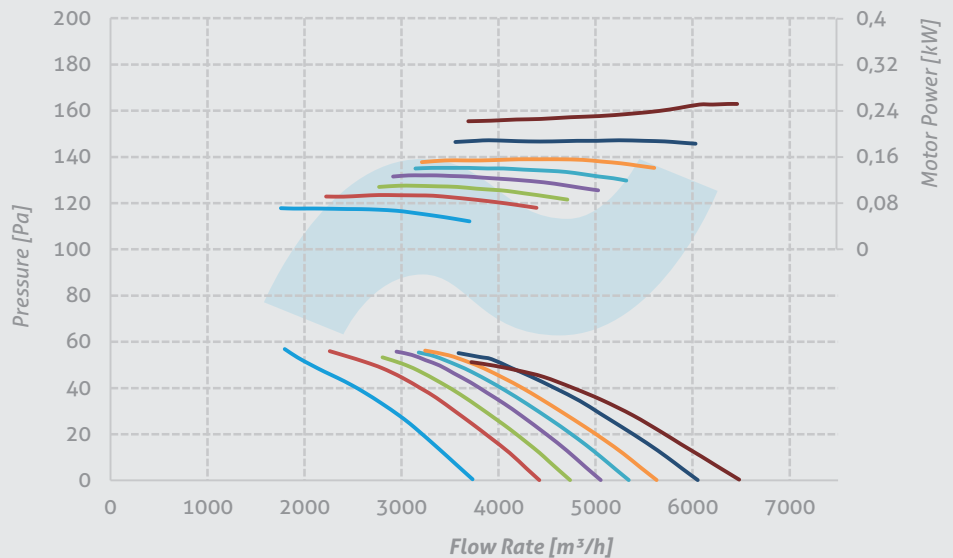

Performans Eğrileri

H-FWA 560

Nos. of Blades 3
Hub Size 6
Pitch Angle 45°
Nos. of Poles 2
Material Aluminum

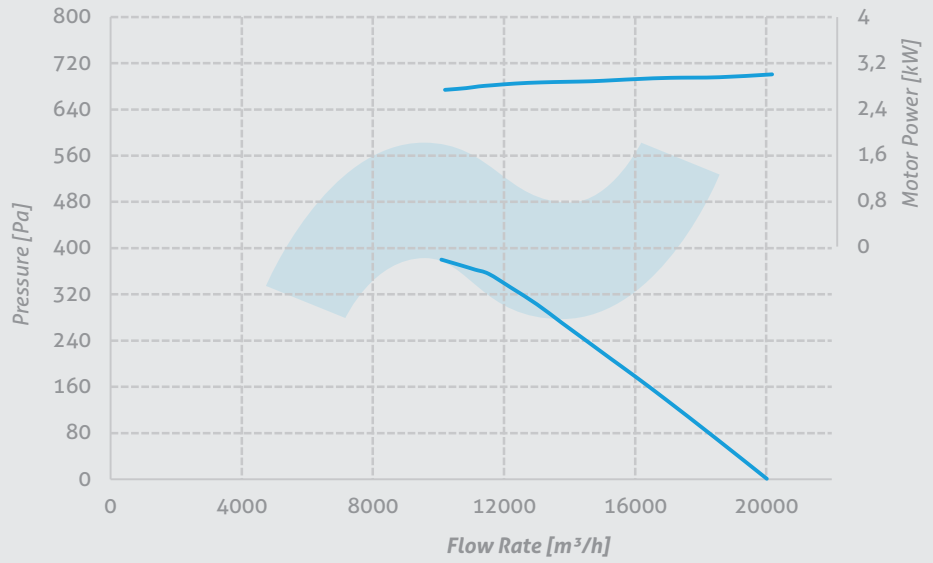

H-FWA 560

Nos. of Blades 3
Hub Size 6
Pitch Angle 45°
Nos. of Poles 4
Material Aluminum

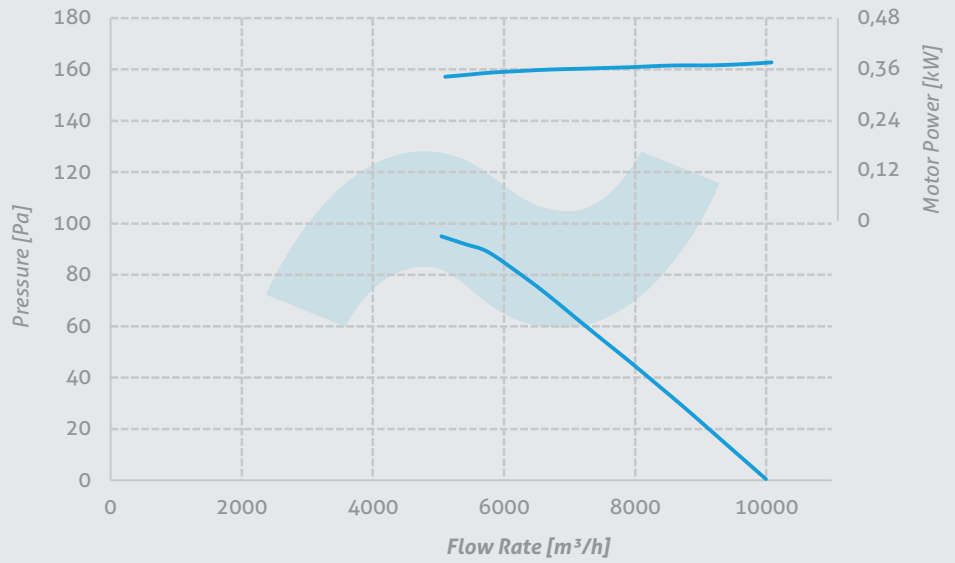

H-FWA 560

Nos. of Blades 3
Hub Size 6
Pitch Angle 45°
Nos. of Poles 6
Material Aluminum

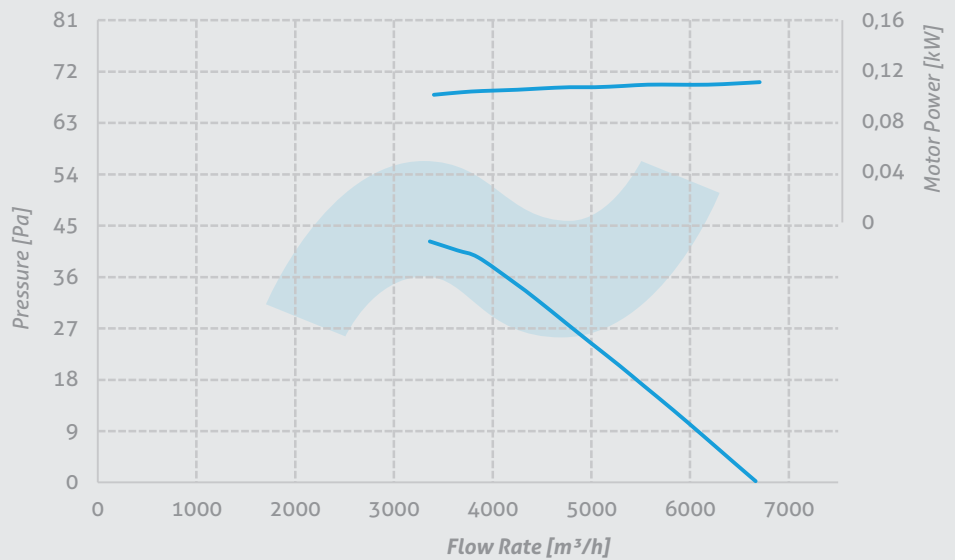

Performans Eğrileri

H-FWA 560

Nos. of Blades 6
Hub Size 6
Pitch Angle 45°
Nos. of Poles 2
Material Aluminum

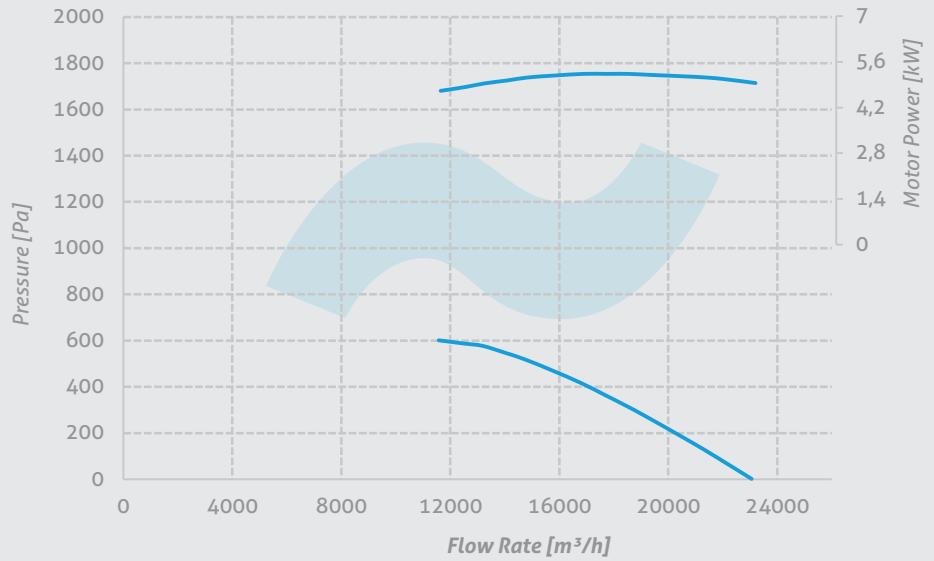

H-FWA 560

Nos. of Blades 6
Hub Size 6
Pitch Angle 45°
Nos. of Poles 4
Material Aluminum

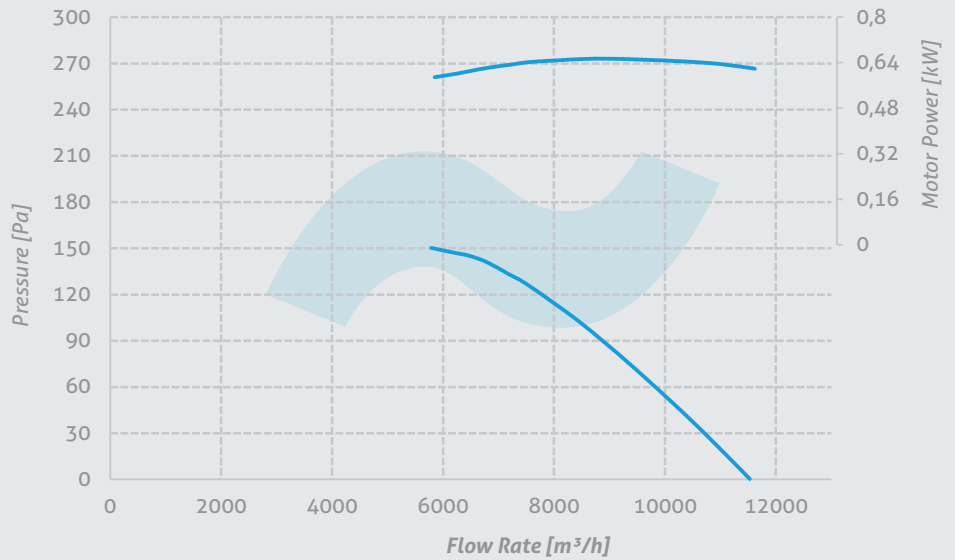

H-FWA 560

Nos. of Blades 6
Hub Size 6
Pitch Angle 45°
Nos. of Poles 6
Material Aluminum

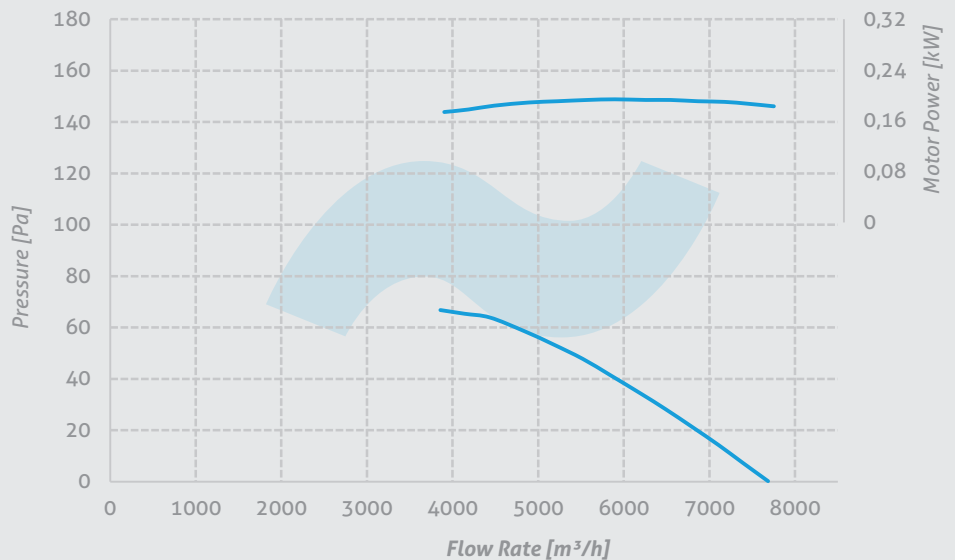

Performans Eğrileri

H-FWA 560

Nos. of Blades 5
 Hub Size 5
 Nos. of Poles 2
 Material Aluminum
 Pitch Angle

- 25° — 30° — 32,5°
- 35° — 37,5° — 40°
- 45° — 50°

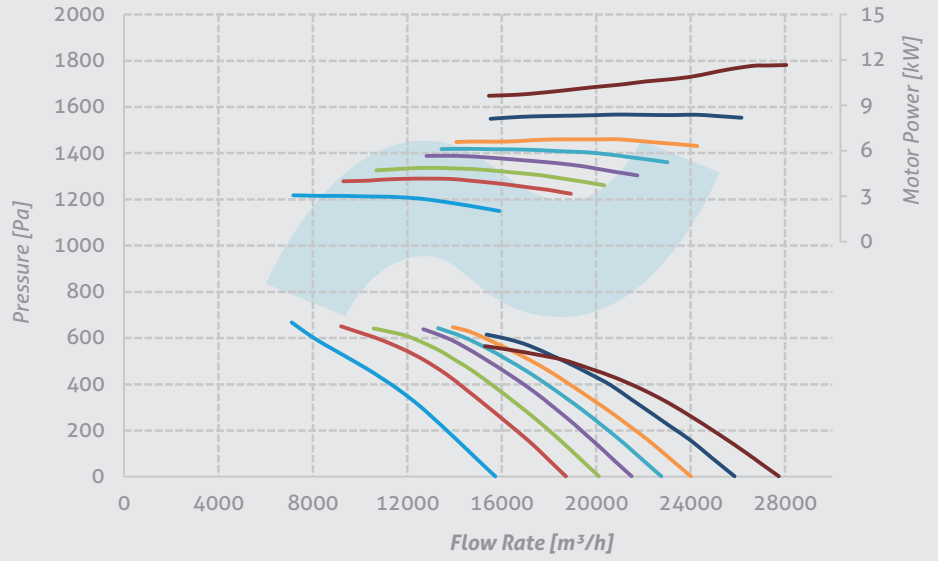

H-FWA 560

Nos. of Blades 5
 Hub Size 5
 Nos. of Poles 4
 Material Aluminum
 Pitch Angle

- 25° — 30° — 32,5°
- 35° — 37,5° — 40°
- 45° — 50°

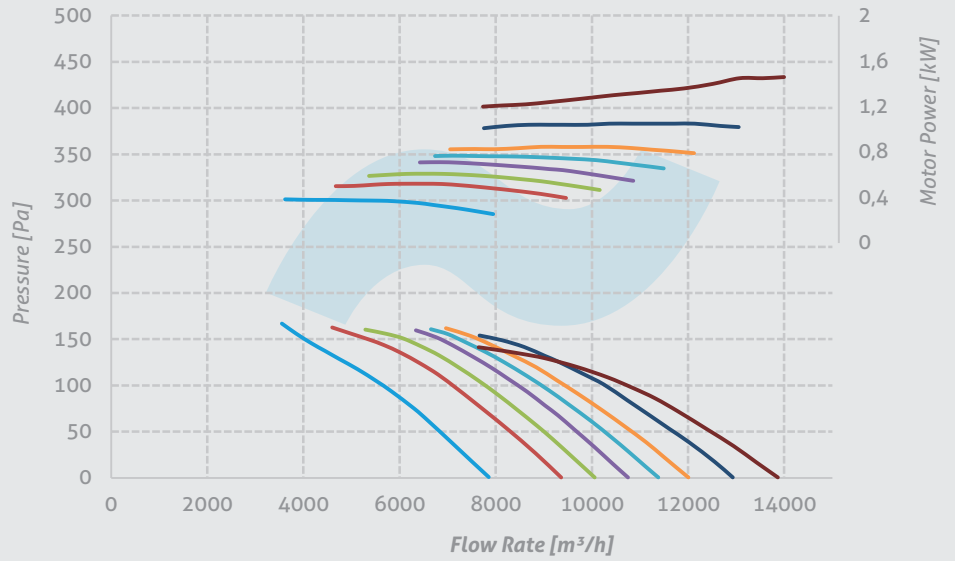

H-FWA 560

Nos. of Blades 5
 Hub Size 5
 Nos. of Poles 6
 Material Aluminum
 Pitch Angle

- 25° — 30° — 32,5°
- 35° — 37,5° — 40°
- 45° — 50°

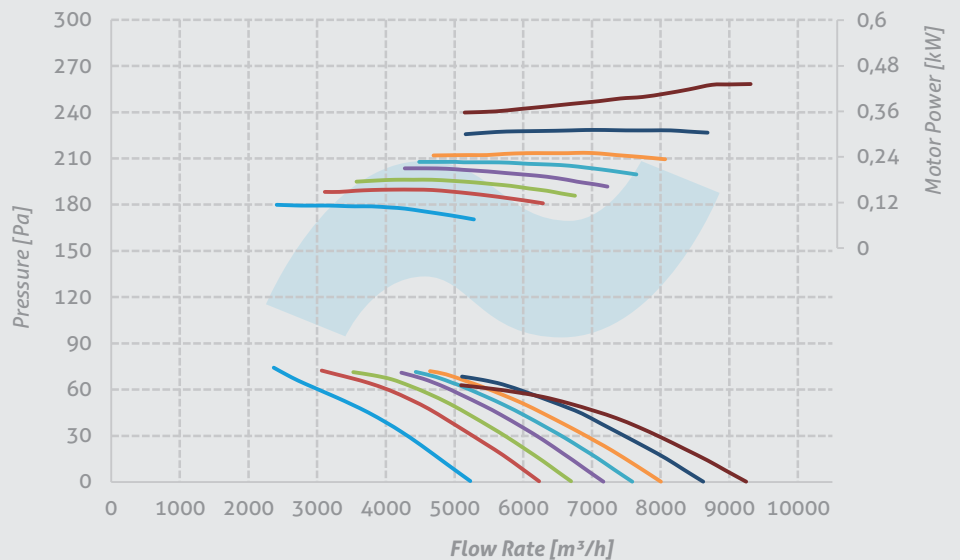

Performans Eğrileri

H-FWA 630

Nos. of Blades 5
 Hub Size 5
 Nos. of Poles 2
 Material Aluminum
 Pitch Angle

- 25° 30° 32,5°
- 35° 37,5° 40°
- 45°

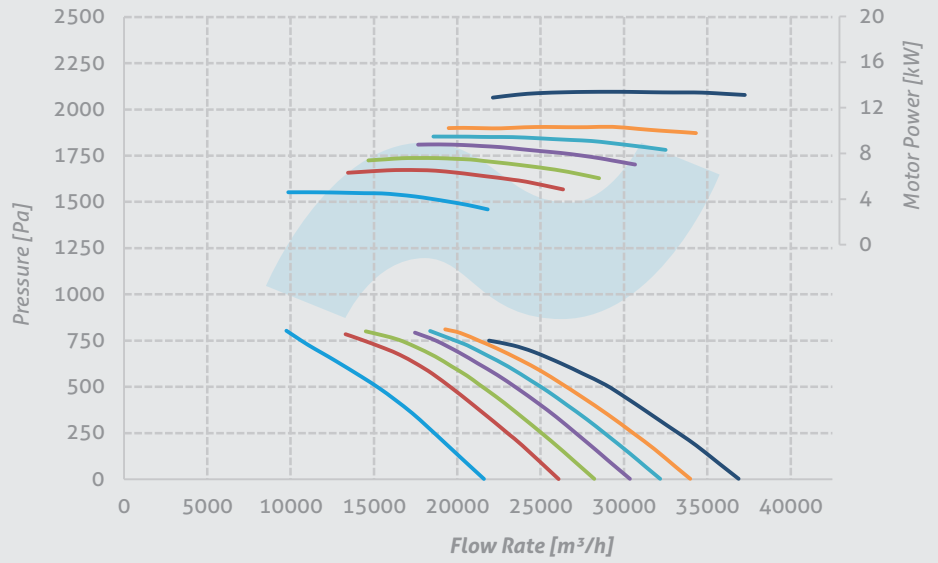

H-FWA 630

Nos. of Blades 5
 Hub Size 5
 Nos. of Poles 4
 Material Aluminum
 Pitch Angle

- 25° 30° 32,5°
- 35° 37,5° 40°
- 45° 50°

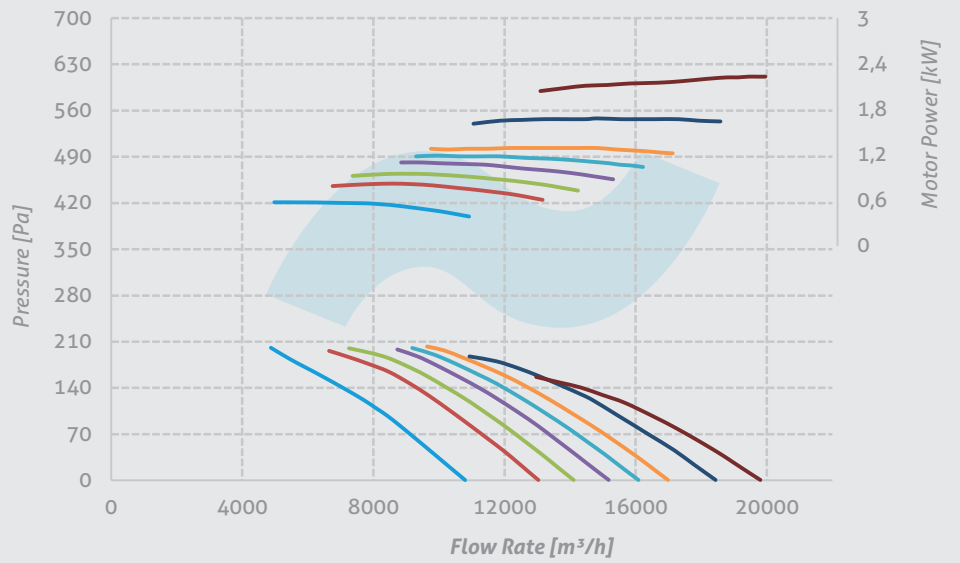

H-FWA 630

Nos. of Blades 5
 Hub Size 5
 Nos. of Poles 6
 Material Aluminum
 Pitch Angle

- 25° 30° 32,5°
- 35° 37,5° 40°
- 45° 50°

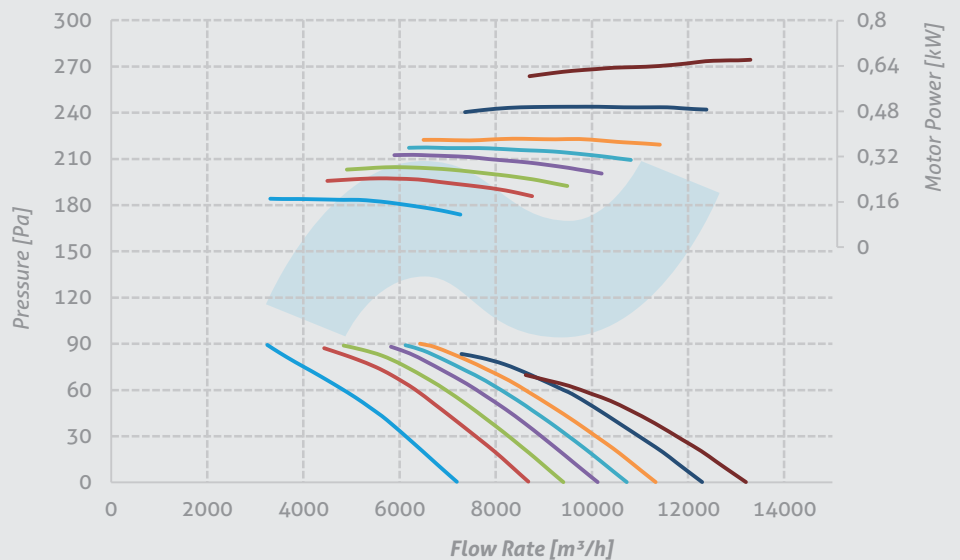

Performans Eğrileri

H-FWA 630

Nos. of Blades 8
 Hub Size 8
 Nos. of Poles 2
 Material Aluminum
 Pitch Angle

25° 30°
 32,5° 35°

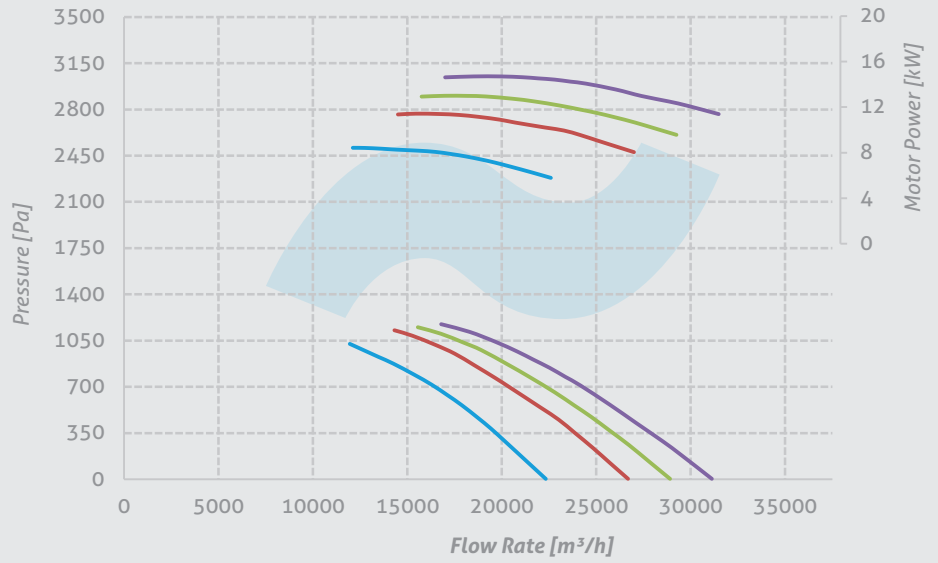

H-FWA 630

Nos. of Blades 8
 Hub Size 8
 Nos. of Poles 4
 Material Aluminum
 Pitch Angle

25° 30° 32,5°
 35° 37,5° 40°
 45° 50°

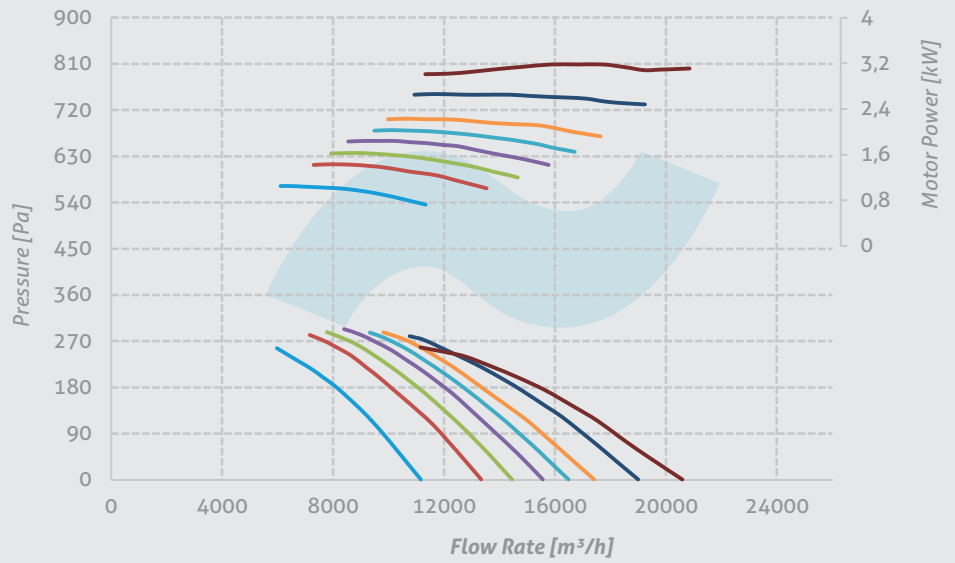

H-FWA 630

Nos. of Blades 8
 Hub Size 8
 Nos. of Poles 6
 Material Aluminum
 Pitch Angle

25° 30° 32,5°
 35° 37,5° 40°
 45° 50°

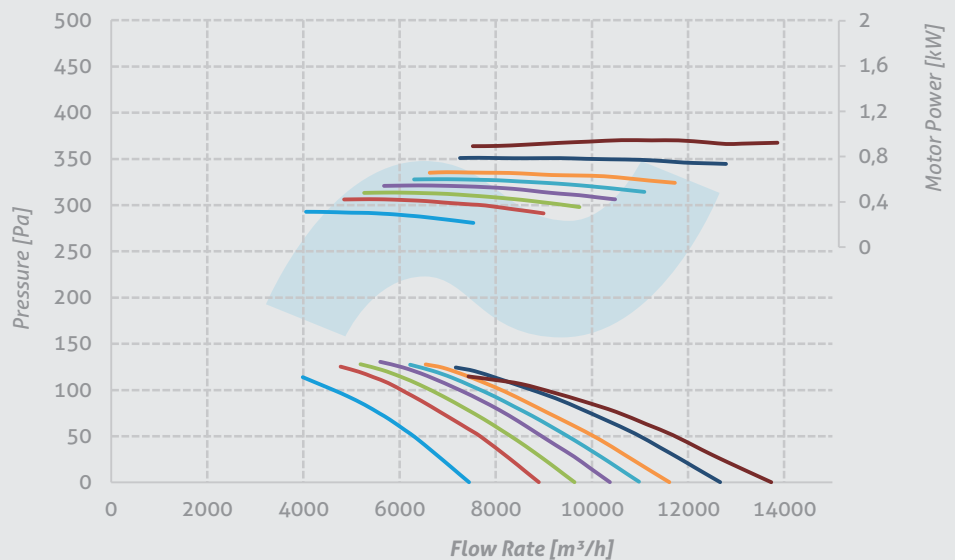

Performans Eğrileri

H-FWA 710

Nos. of Blades 5
 Hub Size 5
 Nos. of Poles 4
 Material Aluminum
 Pitch Angle

- 25° — 30° — 32,5°
- 35° — 37,5° — 40°
- 45° — 50°

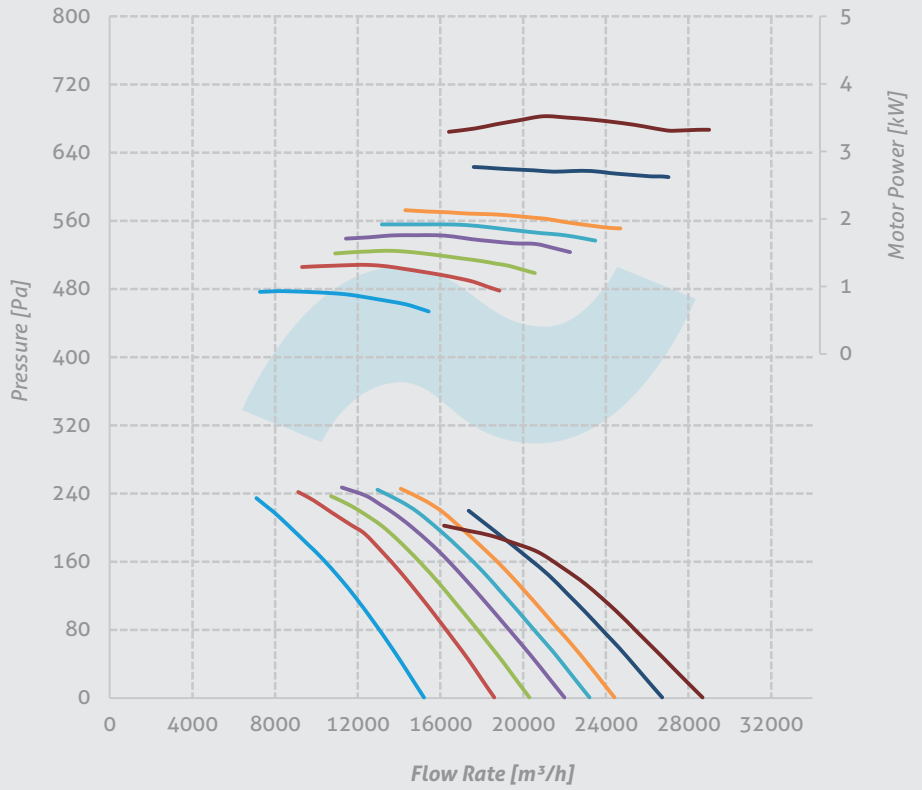

H-FWA 710

Nos. of Blades 5
 Hub Size 5
 Nos. of Poles 6
 Material Aluminum
 Pitch Angle

- 25° — 30° — 32,5°
- 35° — 37,5° — 40°
- 45° — 50°

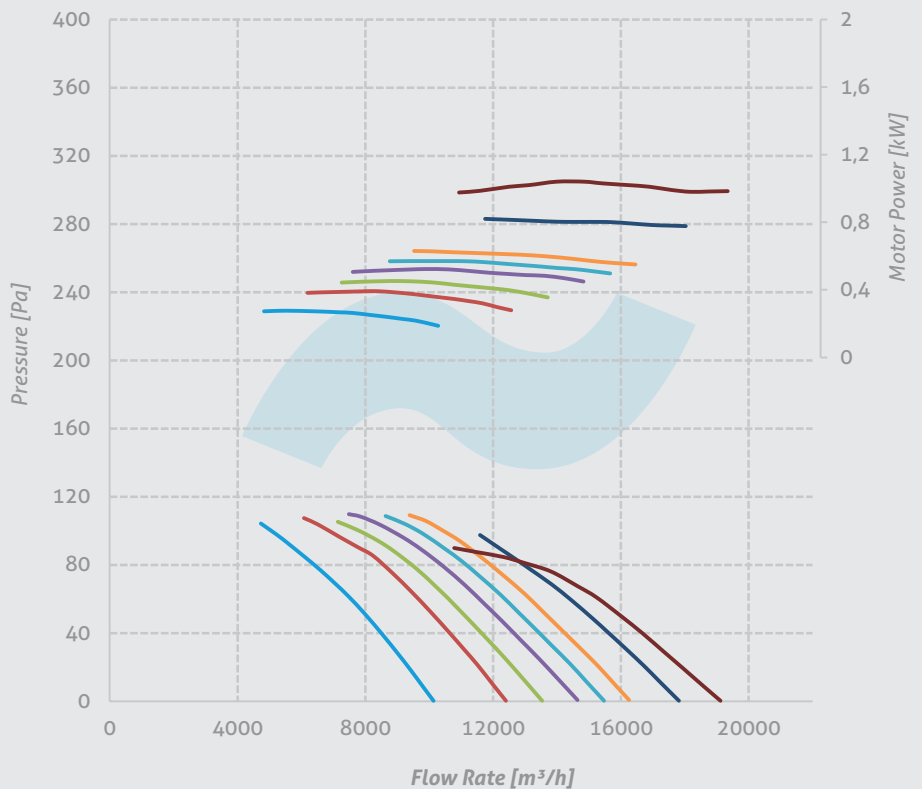

Performans Eğrileri

H-FWA 710

Nos. of Blades 8
 Hub Size 8
 Nos. of Poles 4
 Material Aluminum
 Pitch Angle

- 25° — 30° — 32,5°
- 35° — 37,5° — 40°
- 45° — 50°

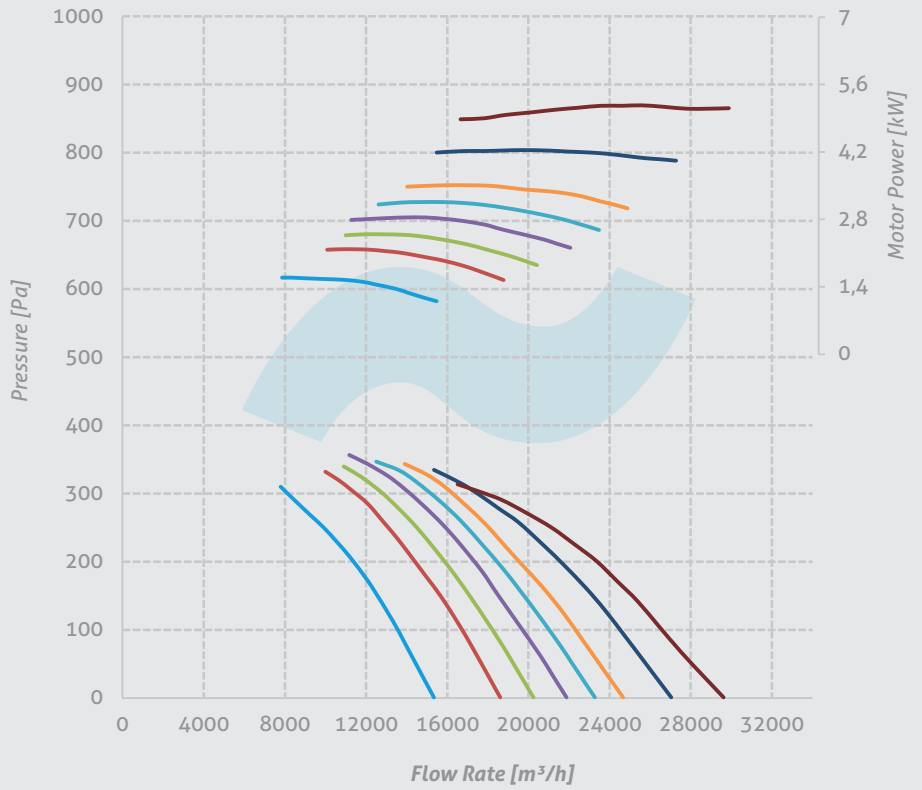

H-FWA 710

Nos. of Blades 8
 Hub Size 8
 Nos. of Poles 6
 Material Aluminum
 Pitch Angle

- 25° — 30° — 32,5°
- 35° — 37,5° — 40°
- 45° — 50°

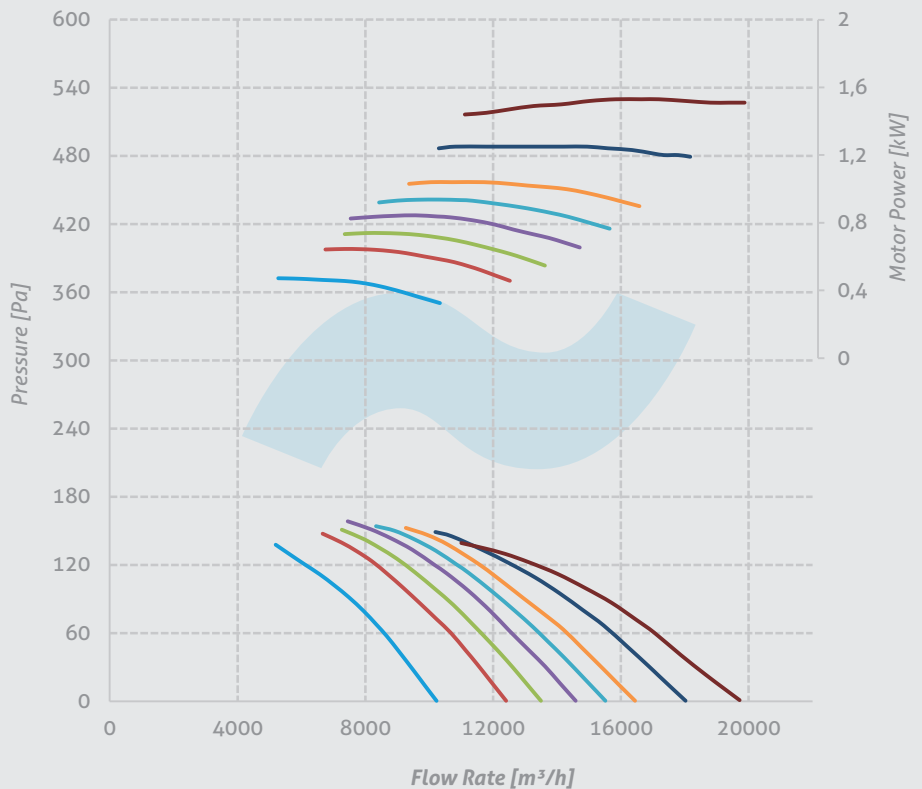

Performans Eğrileri

H-FWA 800

Nos. of Blades 5
 Hub Size 5
 Nos. of Poles 4
 Material Aluminum
 Pitch Angle

- 25° — 30° — 32,5°
- 35° — 37,5° — 40°
- 45° — 50°

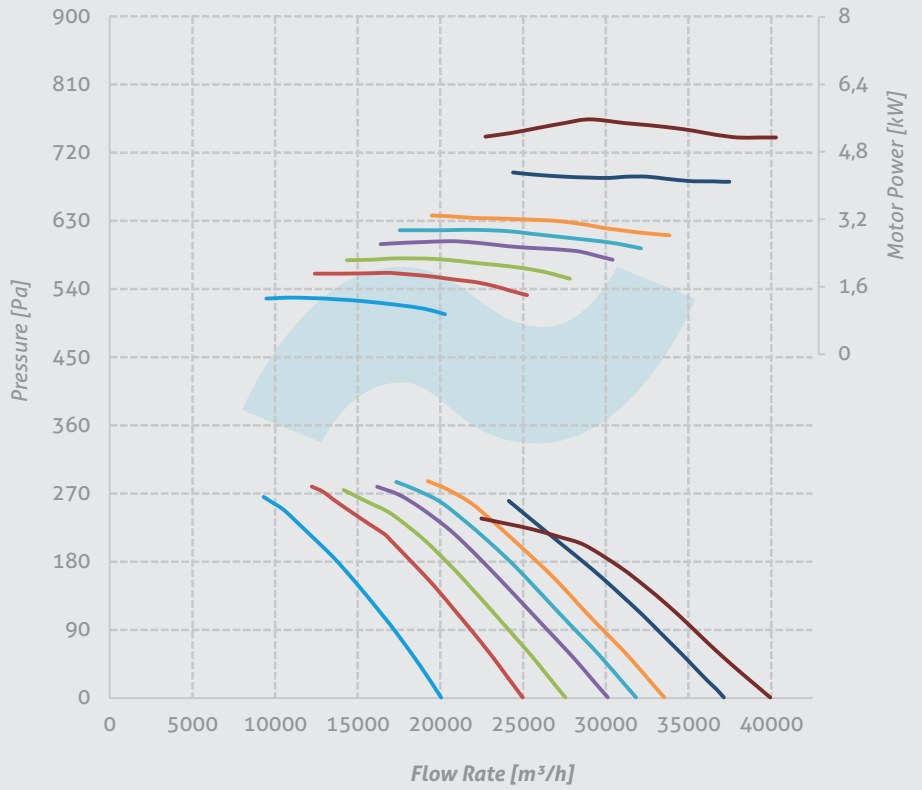

H-FWA 800

Nos. of Blades 5
 Hub Size 5
 Nos. of Poles 6
 Material Aluminum
 Pitch Angle

- 25° — 30° — 32,5°
- 35° — 37,5° — 40°
- 45° — 50°

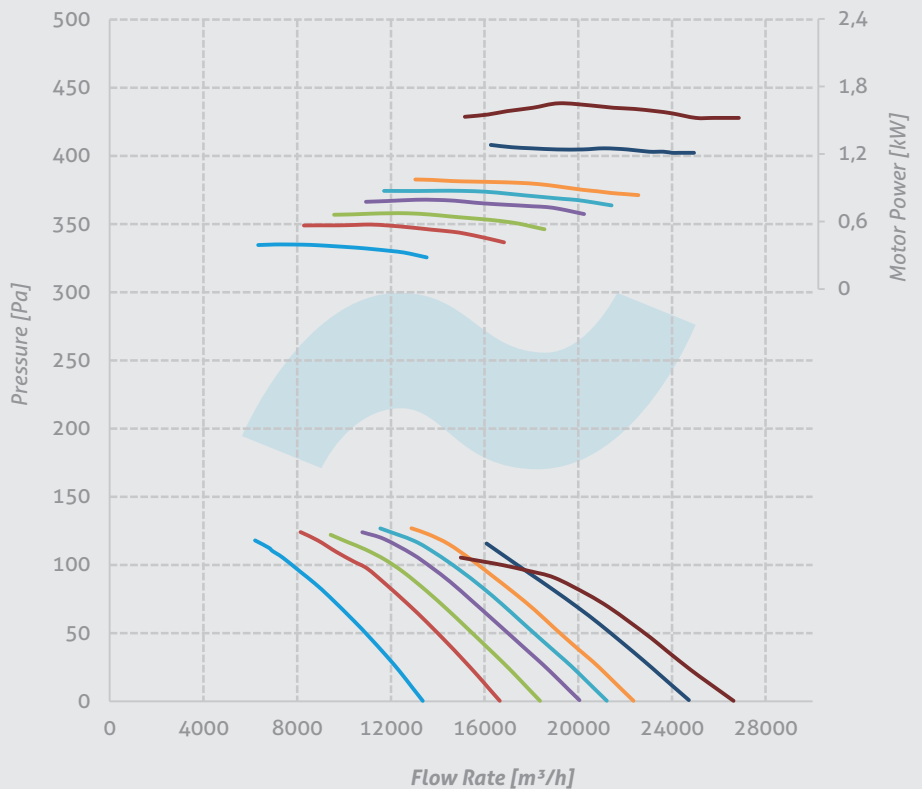

Performans Eğrileri

H-FWA 800

Nos. of Blades 8
 Hub Size 8
 Nos. of Poles 4
 Material Aluminum
 Pitch Angle

- 25° — 30° — 32,5°
- 35° — 37,5° — 40°
- 45° — 50°

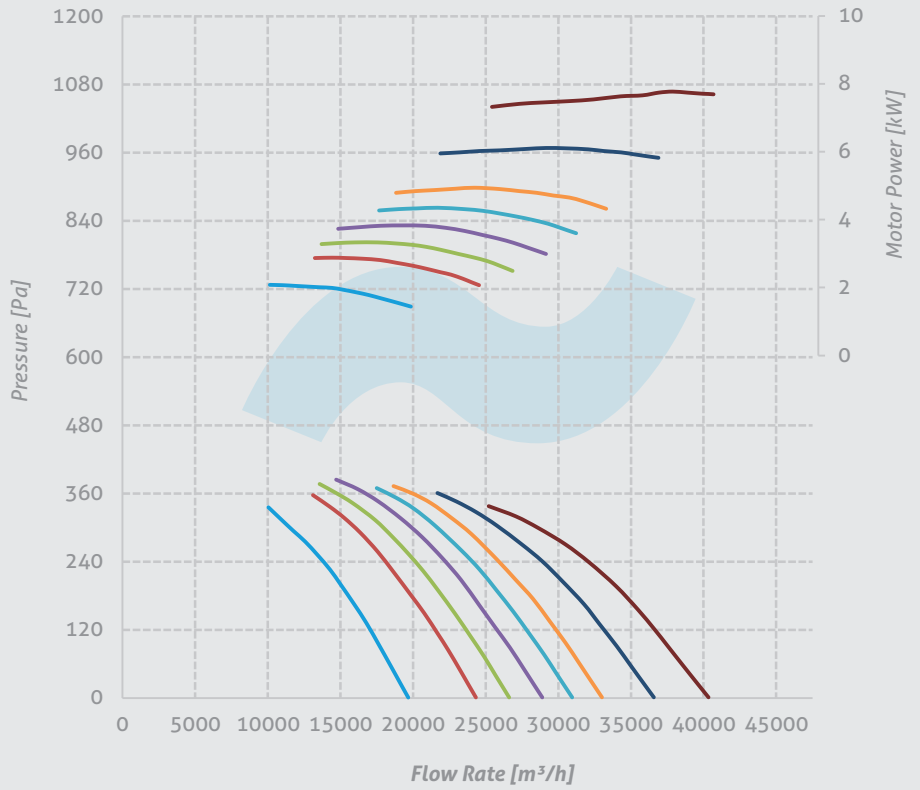

H-FWA 800

Nos. of Blades 8
 Hub Size 8
 Nos. of Poles 6
 Material Aluminum
 Pitch Angle

- 25° — 30° — 32,5°
- 35° — 37,5° — 40°
- 45° — 50°

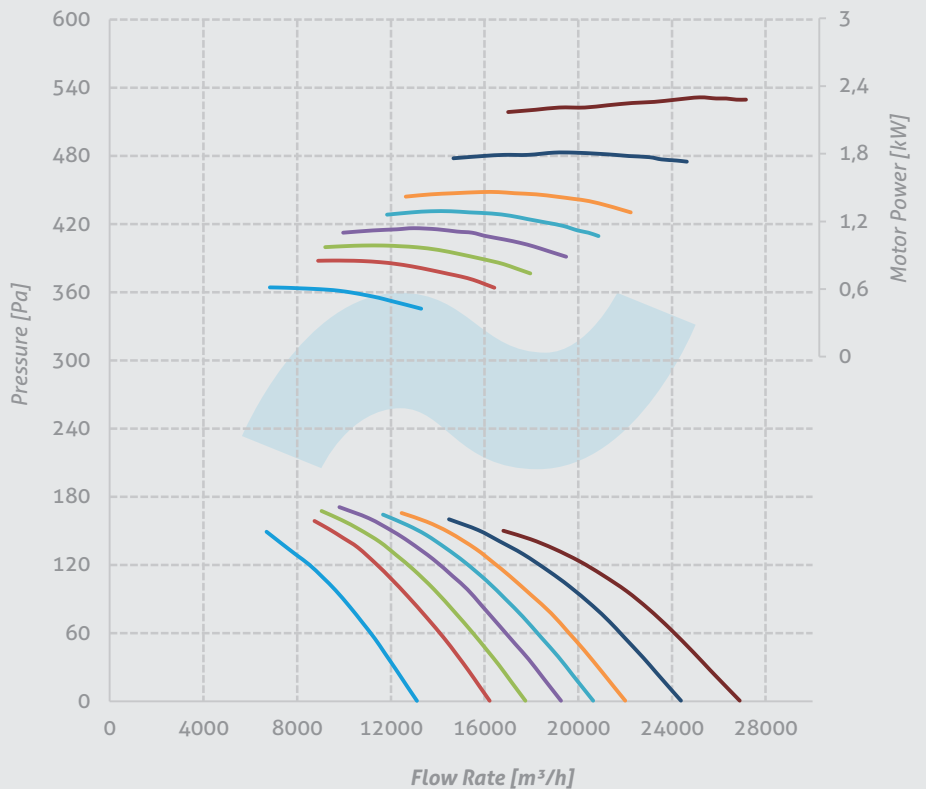

Performans Eğrileri

H-FWA 900

Nos. of Blades 5
 Hub Size 5
 Nos. of Poles 4
 Material Aluminum
 Pitch Angle

- 25° — 30° — 32,5°
- 35° — 37,5° — 40°
- 45° — 50°

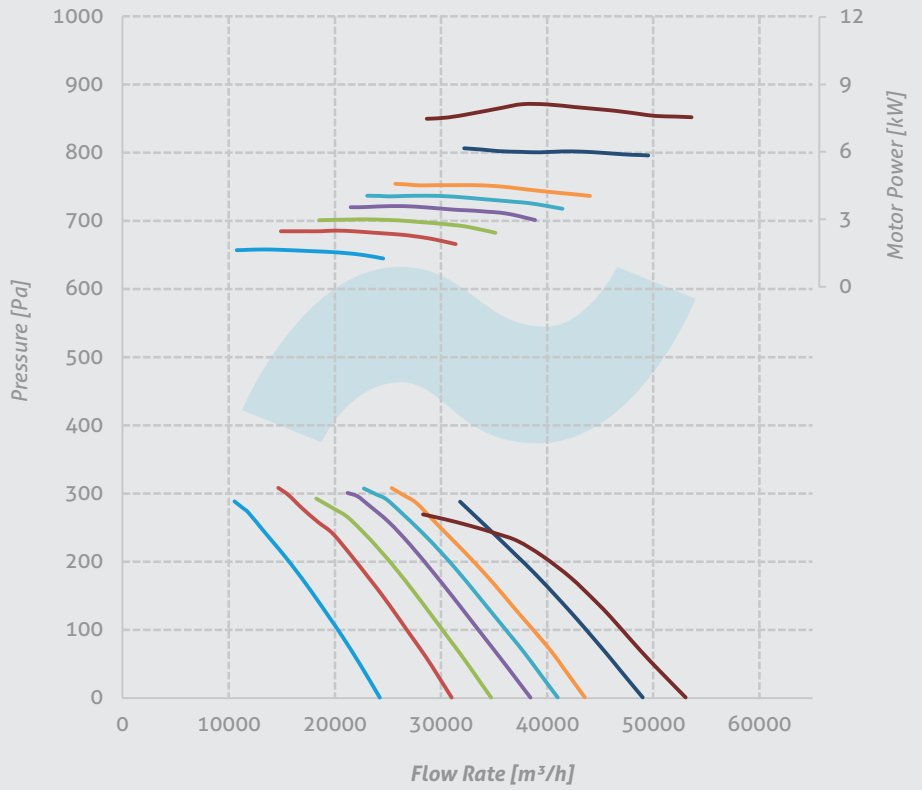

H-FWA 900

Nos. of Blades 5
 Hub Size 5
 Nos. of Poles 6
 Material Aluminum
 Pitch Angle

- 25° — 30° — 32,5°
- 35° — 37,5° — 40°
- 45° — 50°

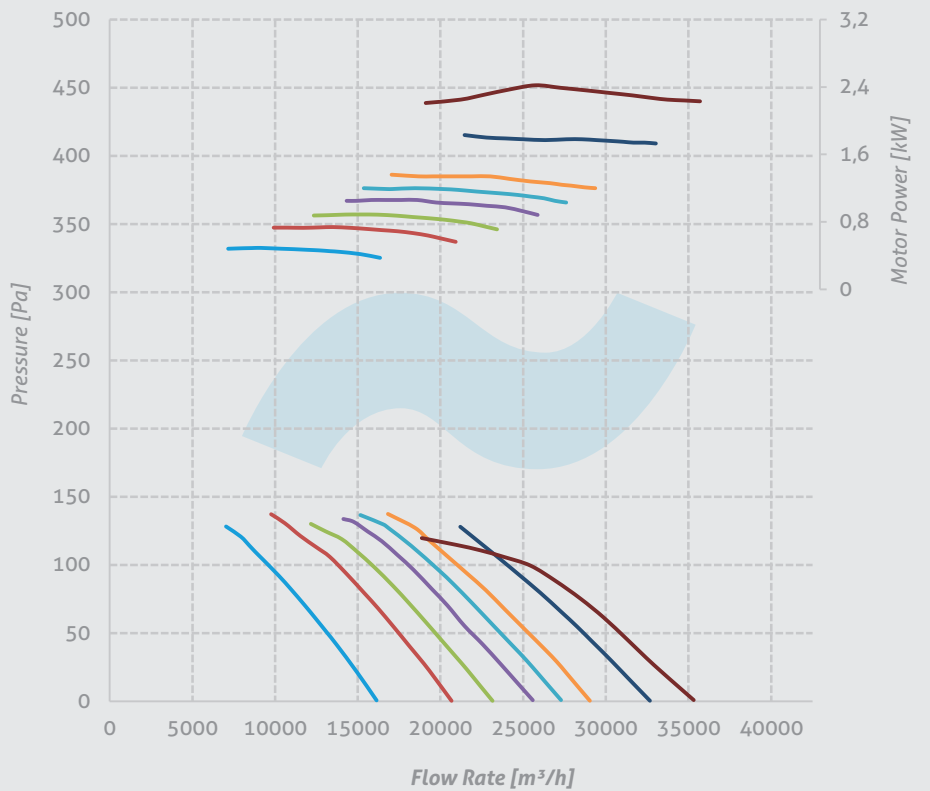

Performans Eğrileri

H-FWA 900

Nos. of Blades 8
 Hub Size 8
 Nos. of Poles 4
 Material Aluminum
 Pitch Angle

- 25° — 30° — 32,5°
- 35° — 37,5° — 40°
- 45° — 50°

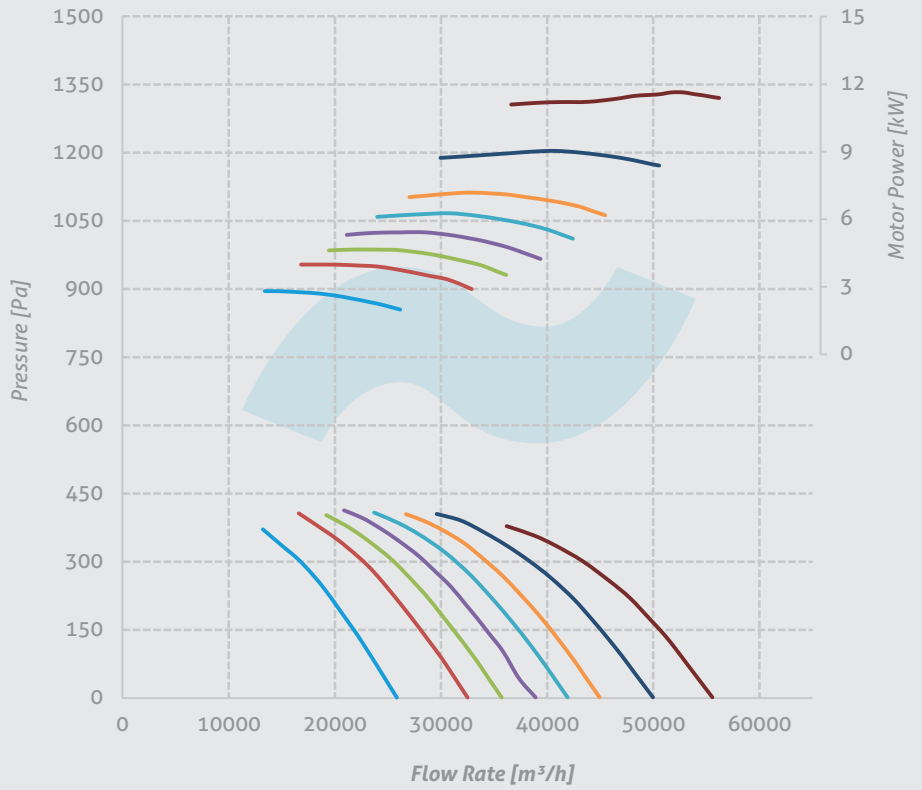

H-FWA 900

Nos. of Blades 8
 Hub Size 8
 Nos. of Poles 6
 Material Aluminum
 Pitch Angle

- 25° — 30° — 32,5°
- 35° — 37,5° — 40°
- 45° — 50°

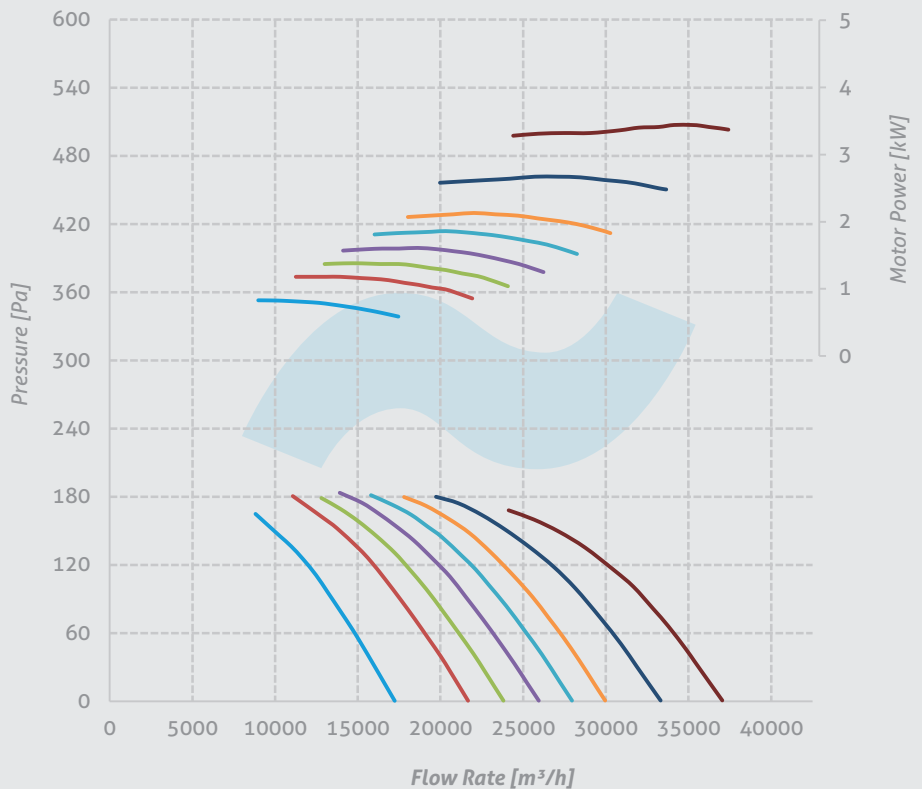

Performans Eğrileri

H-FWA 1000

Nos. of Blades 5
 Hub Size 5
 Nos. of Poles 4
 Material Aluminum
 Pitch Angle

- 25° — 30° — 32,5°
- 35° — 37,5° — 40°
- 45° — 50°

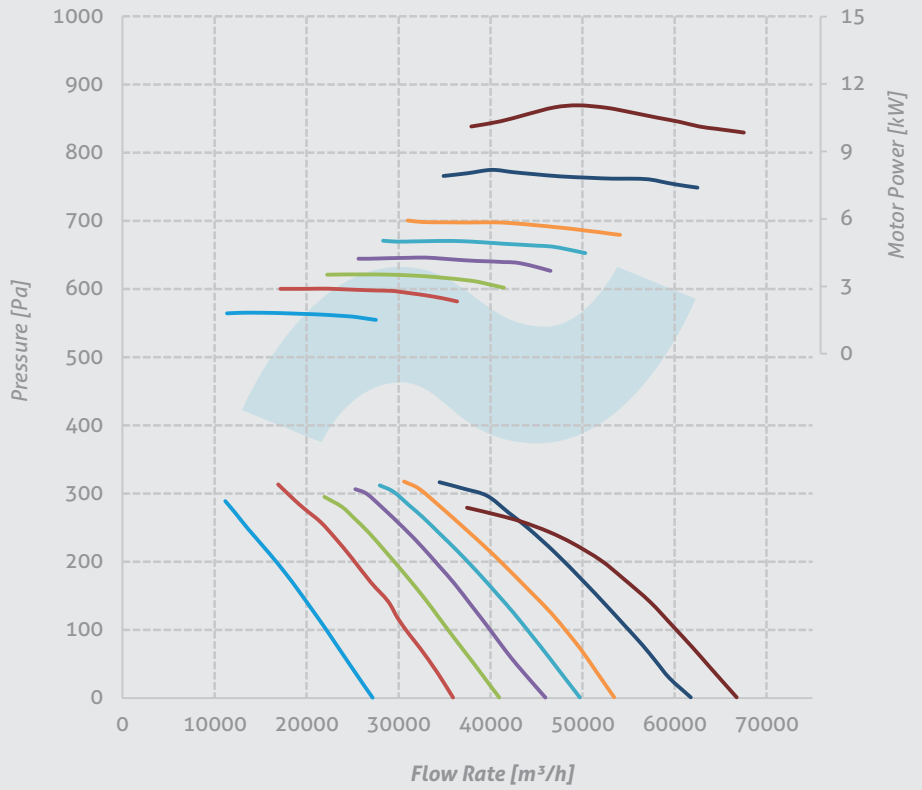

H-FWA 1000

Nos. of Blades 5
 Hub Size 5
 Nos. of Poles 6
 Material Aluminum
 Pitch Angle

- 25° — 30° — 32,5°
- 35° — 37,5° — 40°
- 45° — 50°

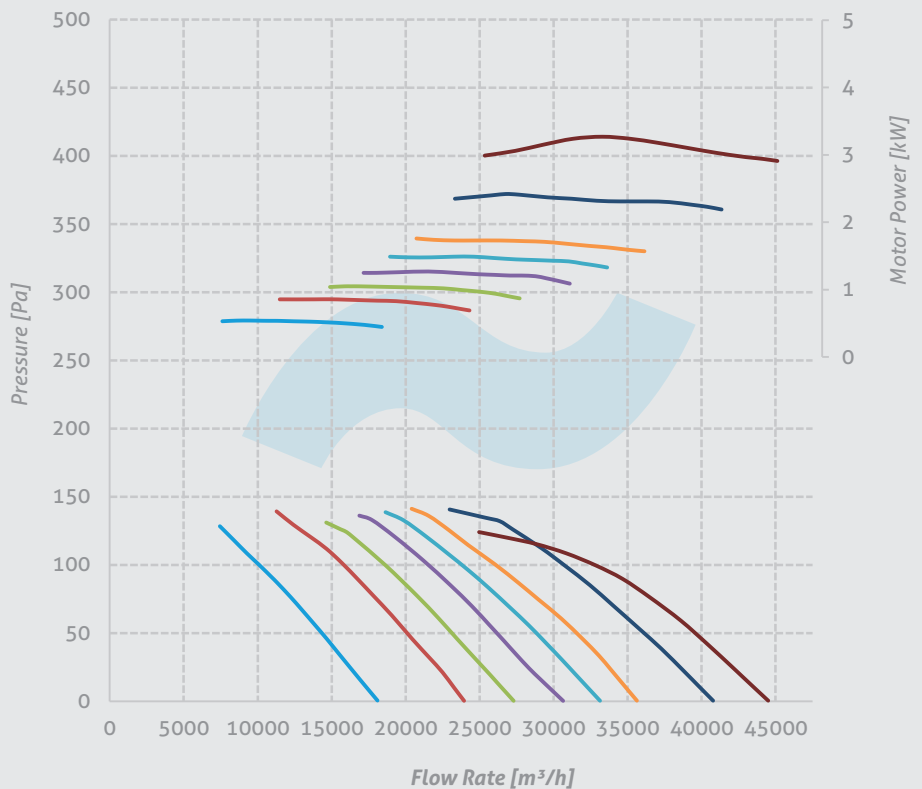

Performans Eğrileri

H-FWA 1000

Nos. of Blades 8
 Hub Size 8
 Nos. of Poles 4
 Material Aluminum
 Pitch Angle

- 25° — 30° — 32,5°
- 35° — 37,5° — 40°
- 45° — 50°

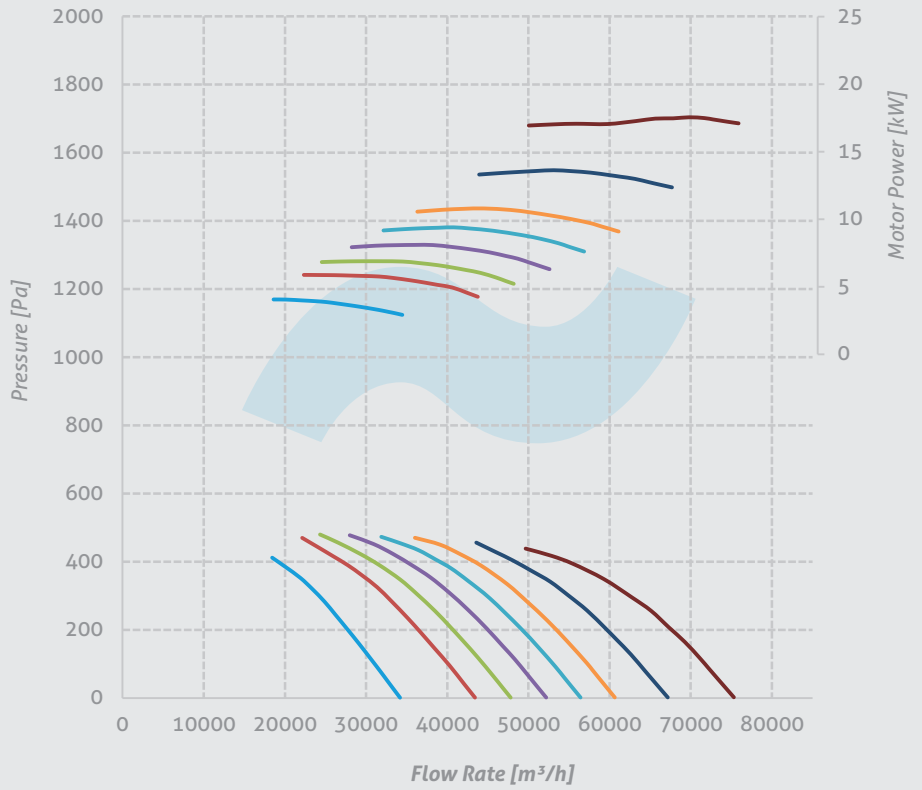

H-FWA 1000

Nos. of Blades 8
 Hub Size 8
 Nos. of Poles 6
 Material Aluminum
 Pitch Angle

- 25° — 30° — 32,5°
- 35° — 37,5° — 40°
- 45° — 50°

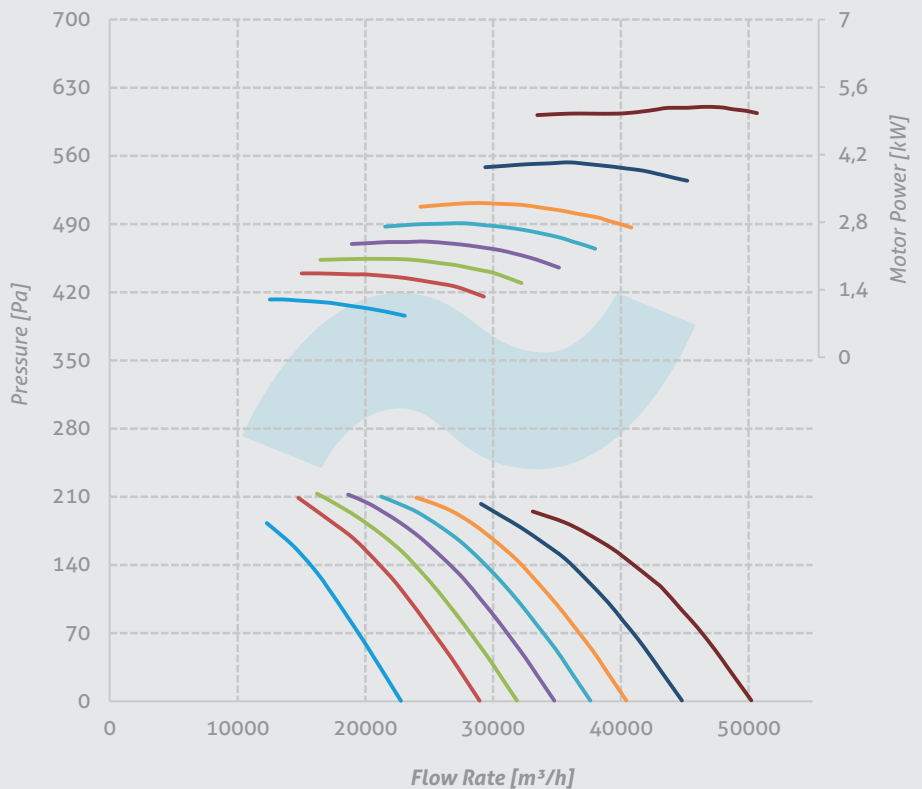

Performans Eğrileri

H-FWA 1120

Nos. of Blades 8
 Hub Size 8
 Nos. of Poles 4
 Material Aluminum
 Pitch Angle

- 25° — 30° — 32,5°
- 35° — 37,5° — 40°
- 45° — 50°

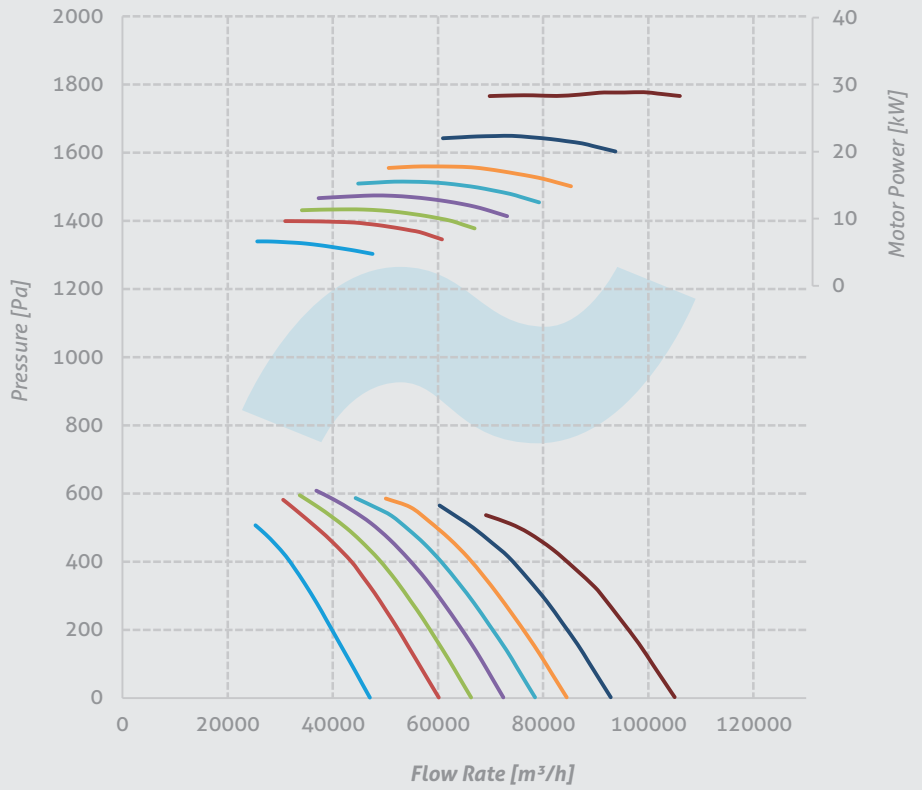

H-FWA 1120

Nos. of Blades 8
 Hub Size 8
 Nos. of Poles 6
 Material Aluminum
 Pitch Angle

- 25° — 30° — 32,5°
- 35° — 37,5° — 40°
- 45° — 50°

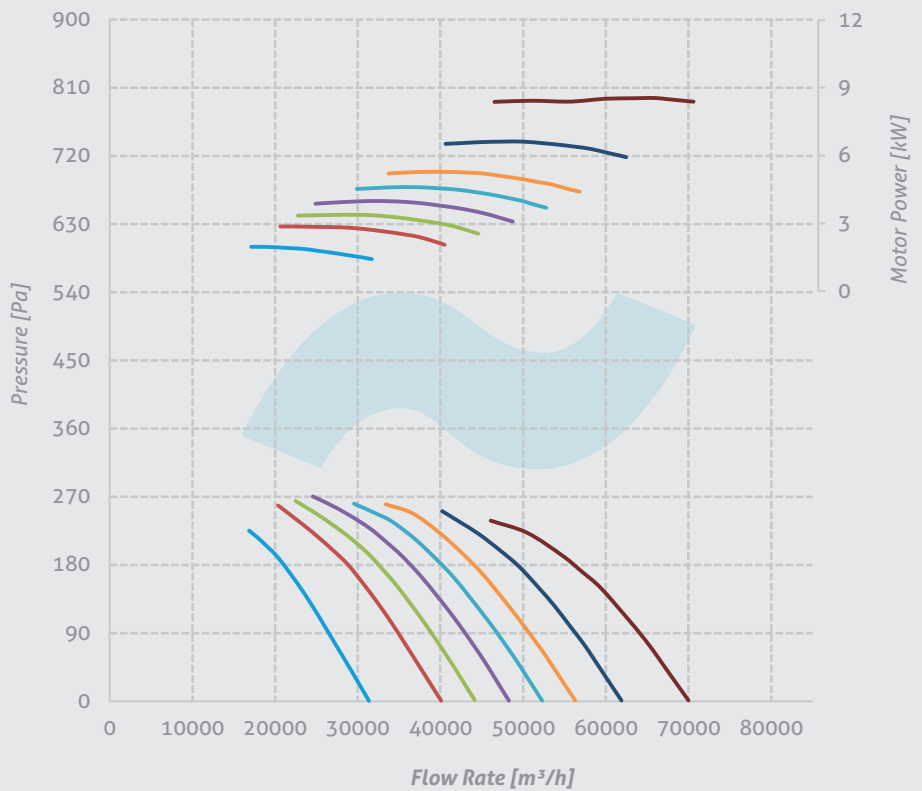

Performans Eğrileri

H-FWA 1120

Nos. of Blades 12
 Hub Size 12
 Nos. of Poles 4
 Material Aluminum
 Pitch Angle

- 25° — 30° — 32,5°
- 35° — 37,5° — 40°
- 45° — 50°

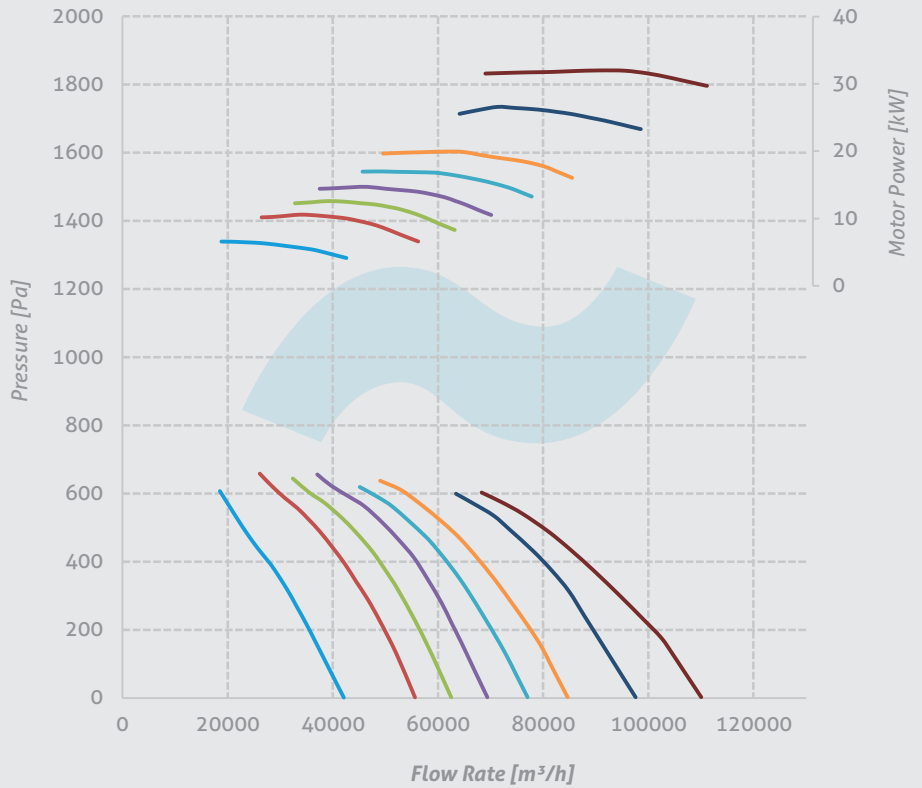

H-FWA 1120

Nos. of Blades 12
 Hub Size 12
 Nos. of Poles 6
 Material Aluminum
 Pitch Angle

- 25° — 30° — 32,5°
- 35° — 37,5° — 40°
- 45° — 50°

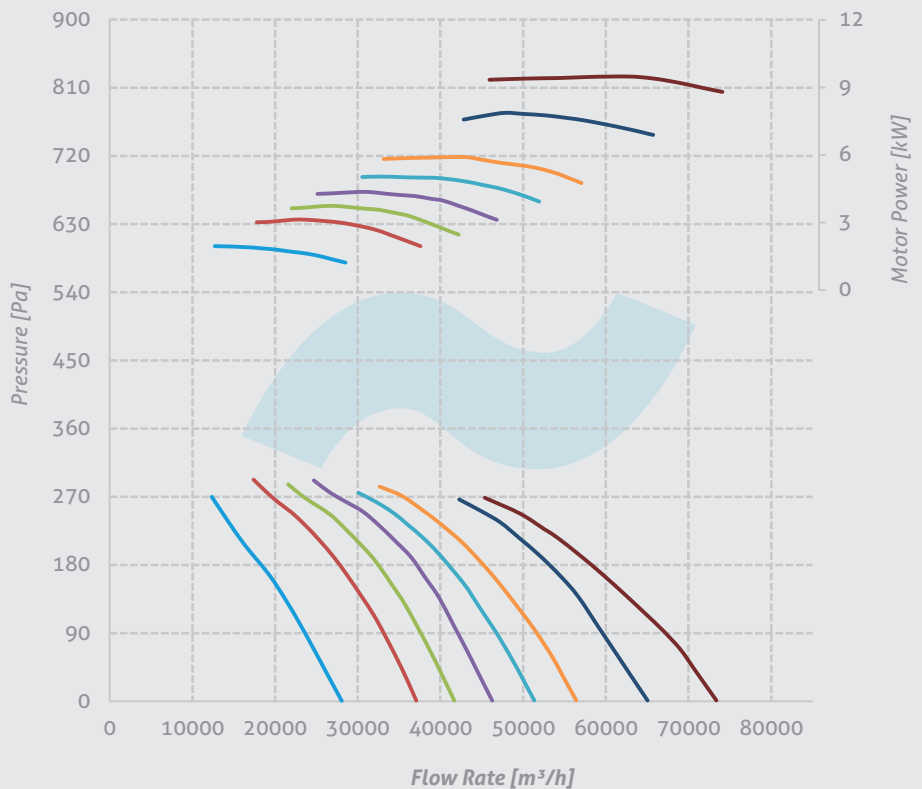

Performans Eğrileri

H-FWA 1250

Nos. of Blades 8
 Hub Size 16
 Nos. of Poles 4
 Material Aluminum
 Pitch Angle

- 25° — 30° — 32,5°
- 35° — 37,5° — 40°
- 45° — 50°

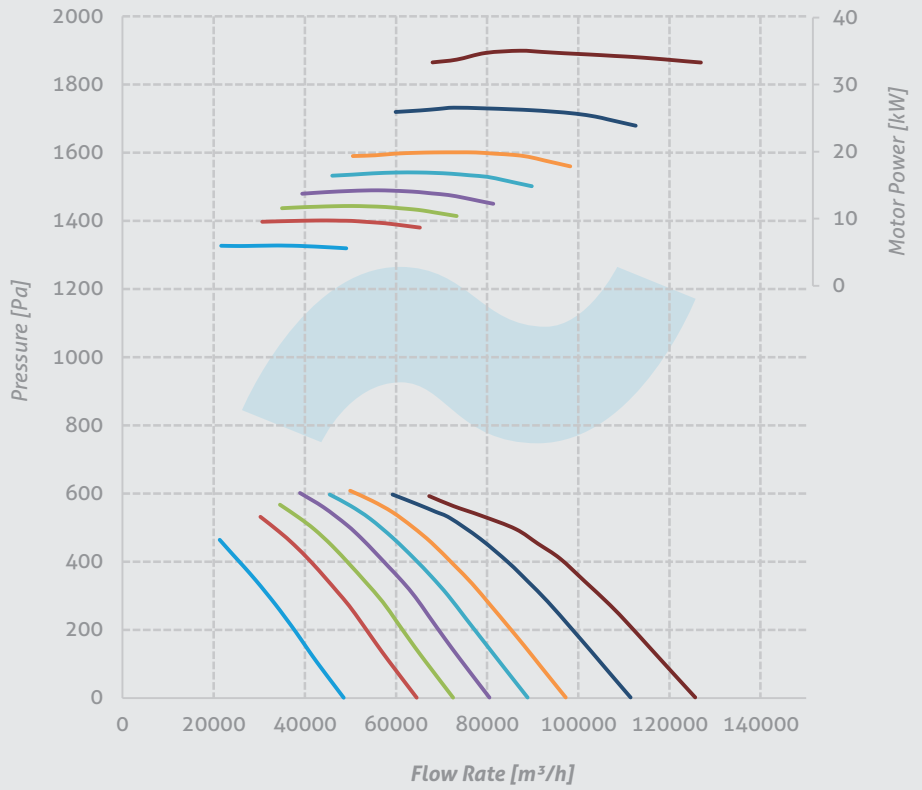

H-FWA 1250

Nos. of Blades 8
 Hub Size 16
 Nos. of Poles 6
 Material Aluminum
 Pitch Angle

- 25° — 30° — 32,5°
- 35° — 37,5° — 40°
- 45° — 50°

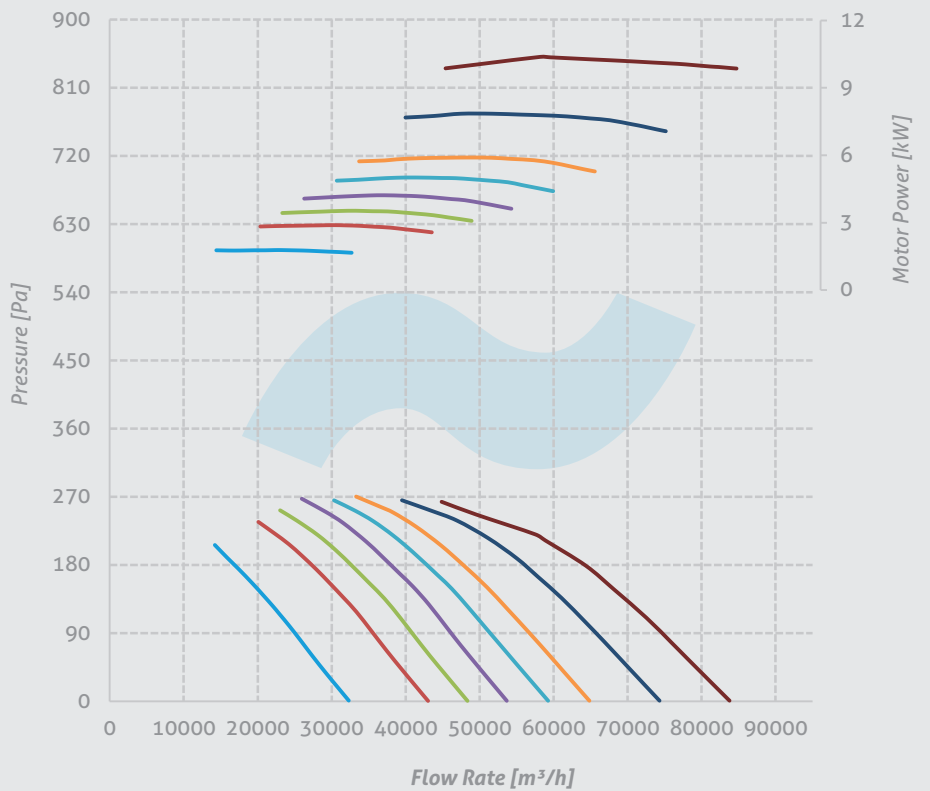

Performans Eğrileri

H-FWA 1250

Nos. of Blades 12
 Hub Size 16
 Nos. of Poles 4
 Material Aluminum
 Pitch Angle

- 25° — 30° — 32,5°
- 35° — 37,5° — 40°
- 45° — 50°

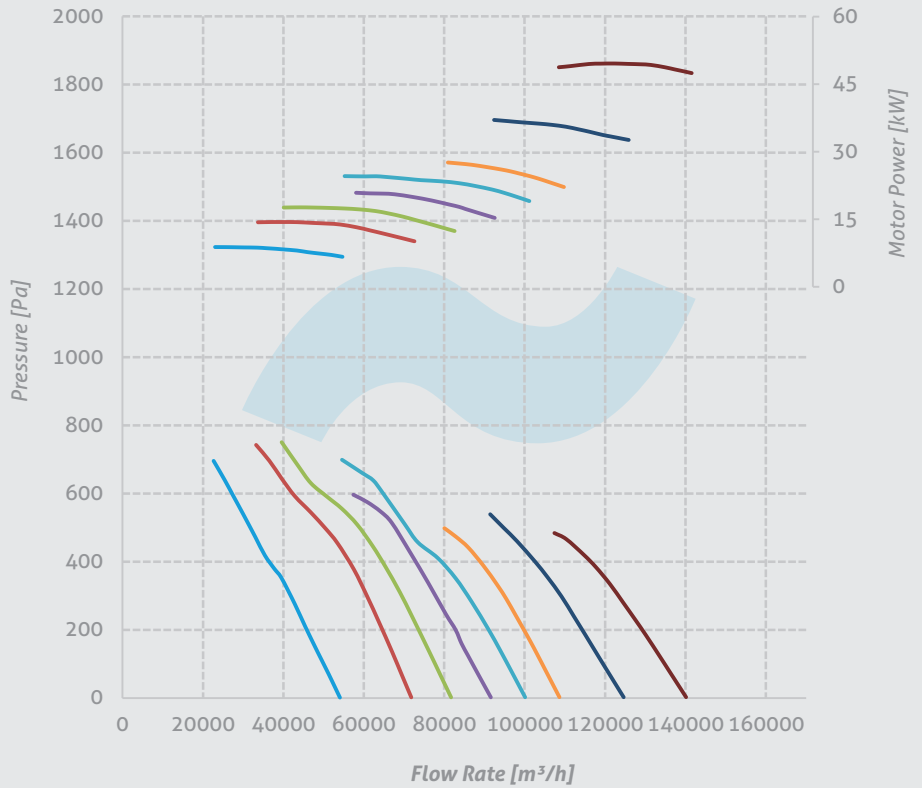

H-FWA 1250

Nos. of Blades 12
 Hub Size 16
 Nos. of Poles 6
 Material Aluminum
 Pitch Angle

- 25° — 30° — 32,5°
- 35° — 37,5° — 40°
- 45° — 50°

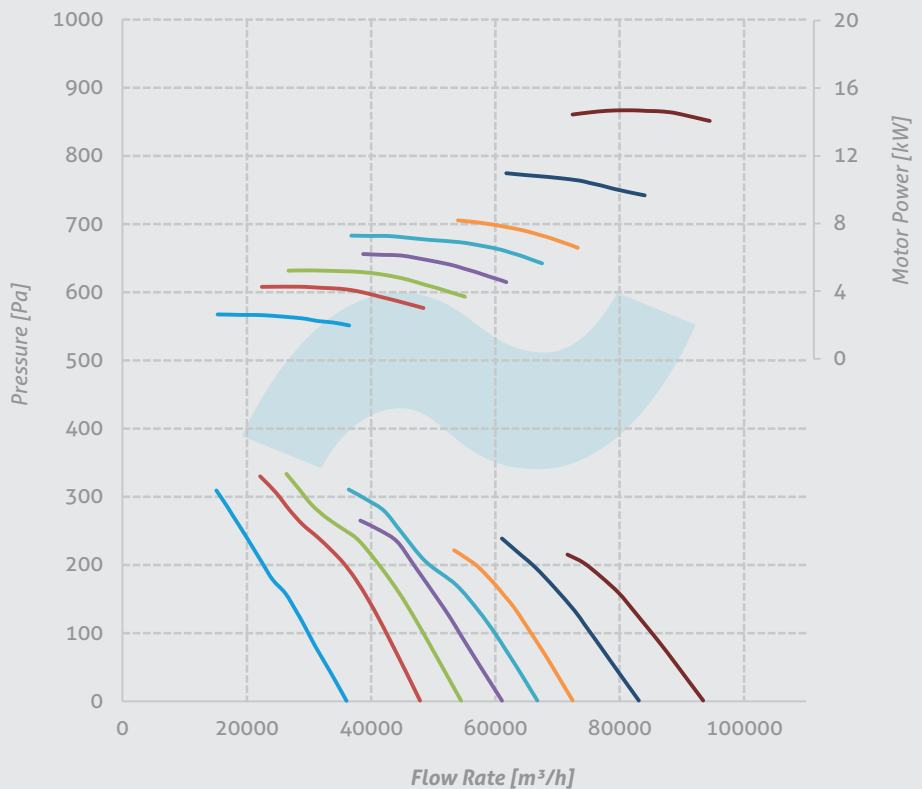

Performans Eğrileri

H-FWA 1250

Nos. of Blades 16
 Hub Size 16
 Nos. of Poles 4
 Material Aluminum
 Pitch Angle

- 25° — 30° — 32,5°
- 35° — 37,5° — 40°
- 45° — 50°

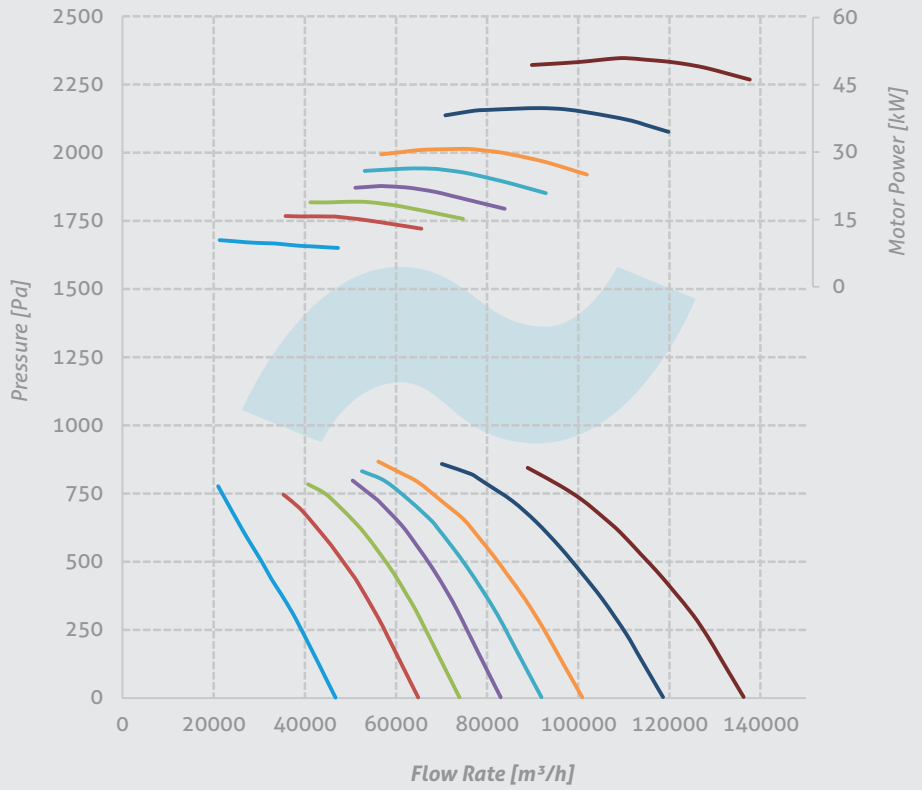

H-FWA 1250

Nos. of Blades 16
 Hub Size 16
 Nos. of Poles 6
 Material Aluminum
 Pitch Angle

- 25° — 30° — 32,5°
- 35° — 37,5° — 40°
- 45° — 50°

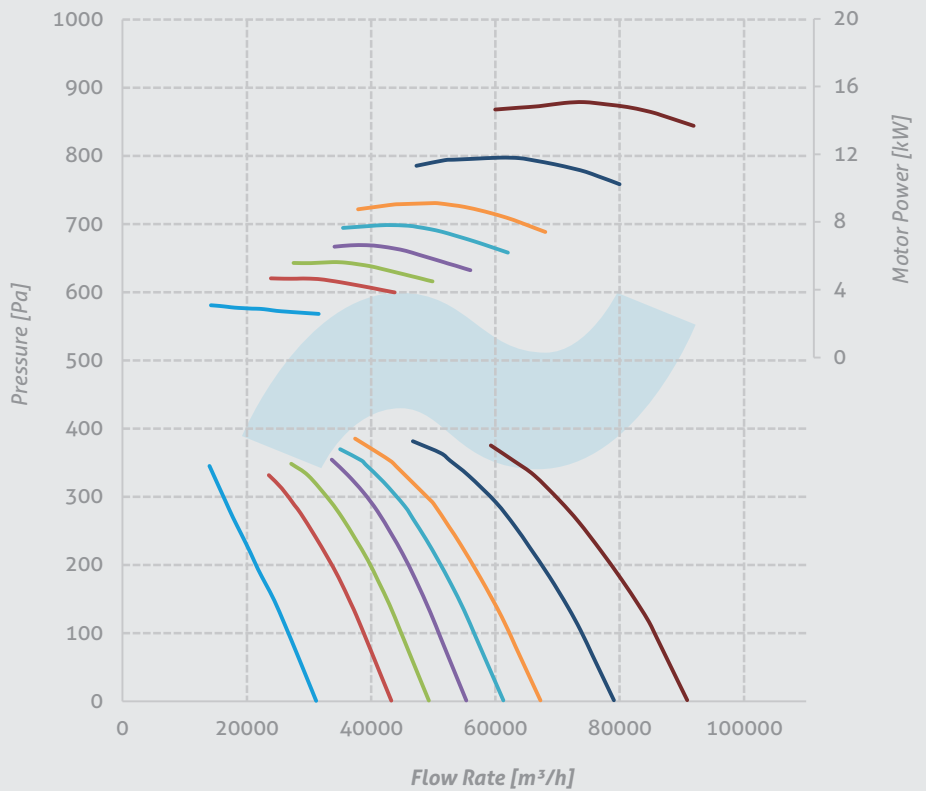

VENTURKA

Contact:

Export Sales Representative: **Mr. Alparslan ASLAN**

Mobile: **+90 538 341 93 11** (WhatsApp: OK)

E-Mail: **export@venturka.com**